

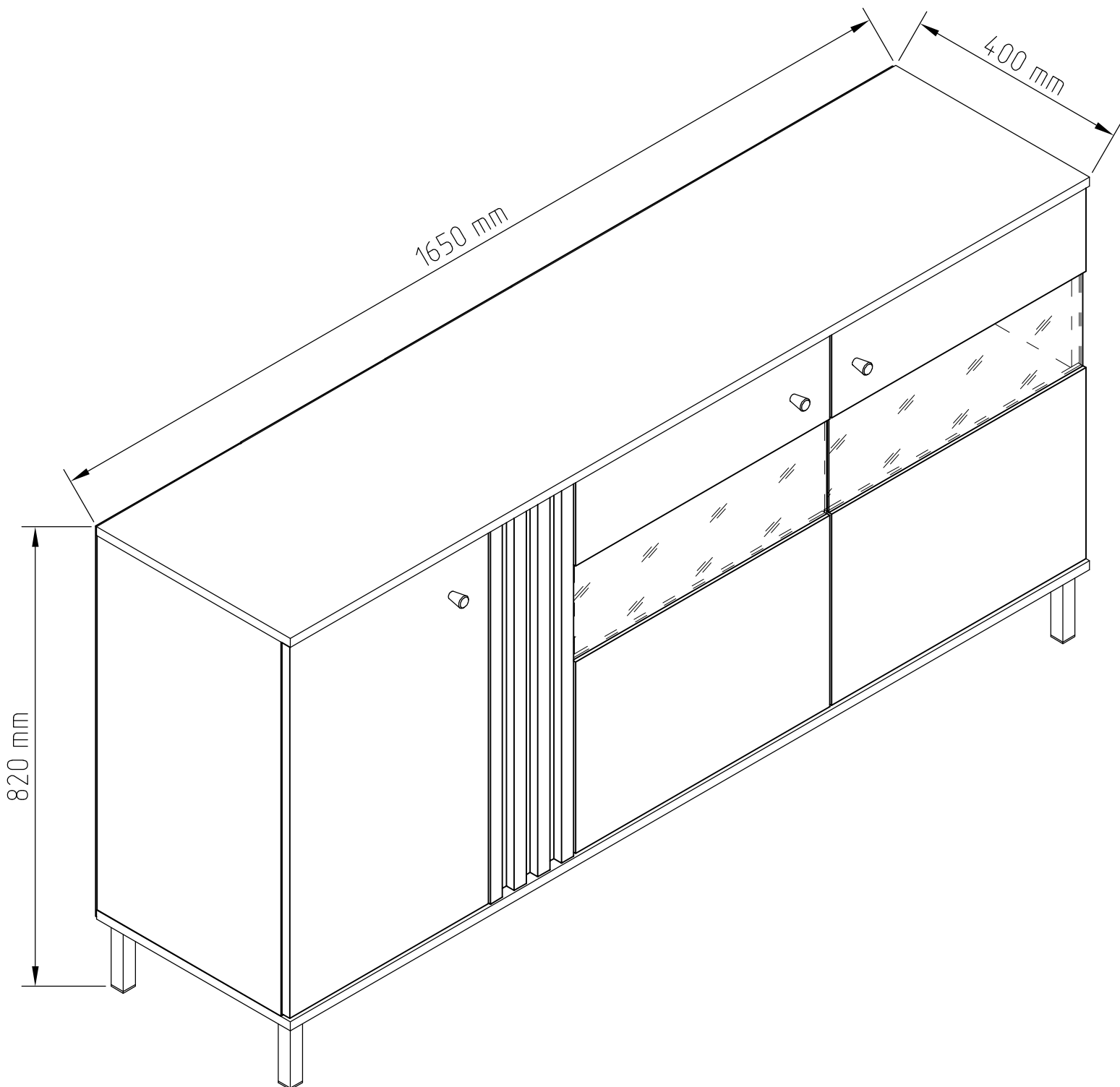

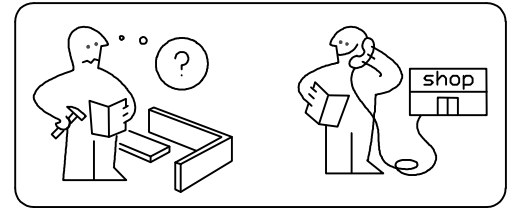

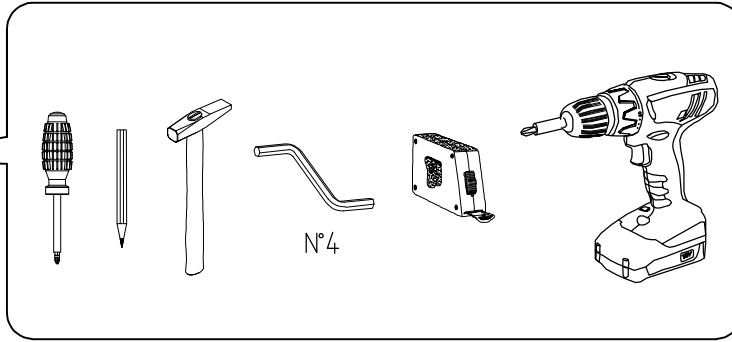

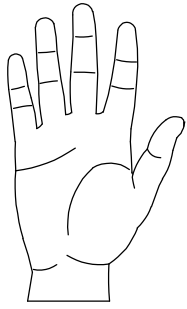

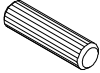

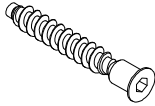
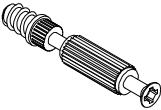

# Teo / Theo

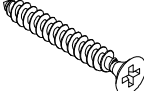
**КОМОД 3Д Ск /  
chest of drawers 3D GI**

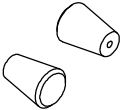
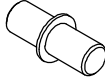
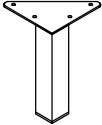
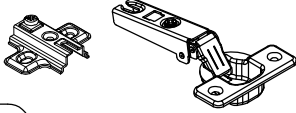

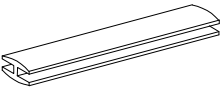

 <b>A1</b> 8*30mm x20	 <b>B</b> $\phi$ 12mm x6	 <b>B1</b> 6,3*50mm x6
 <b>C1</b> 6*43mm x10	 <b>D</b> $\phi$ 20mm x10	 <b>D1</b> 15/16 x10
 <b>E5</b> 3*20mm x6	 <b>E6</b> 3,5*16mm x36	 <b>E15</b> 4*30mm x3
 <b>F4</b> 6,3*13mm x16	 <b>I47</b> x3	 <b>J1</b> 5*16mm x4
 <b>K38</b> h-120mm x5	 <b>L1</b> x8	 <b>O1</b> x6
 <b>O8</b> L-669 mm x3	 <b>R3</b> 1.4*25mm 30g	 <b>U3</b> x4

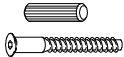
No	a*b	x	N°→...
1L	670x380	x1	2/2
1R	670x380	x1	2/2
2	670x364	x1	2/2
3	1650x400	x1	2/2
4	1650x400	x1	2/2
5	573x360	x1	2/2
6	1026x380	x1	2/2
7	670x208	x1	1/2
8	410x664	x1	1/2
9	525x664	x1	1/2
10	525x664	x1	1/2
11	698x297	x2	2/2
12	698x348	x3	2/2
		x1	1/2

