

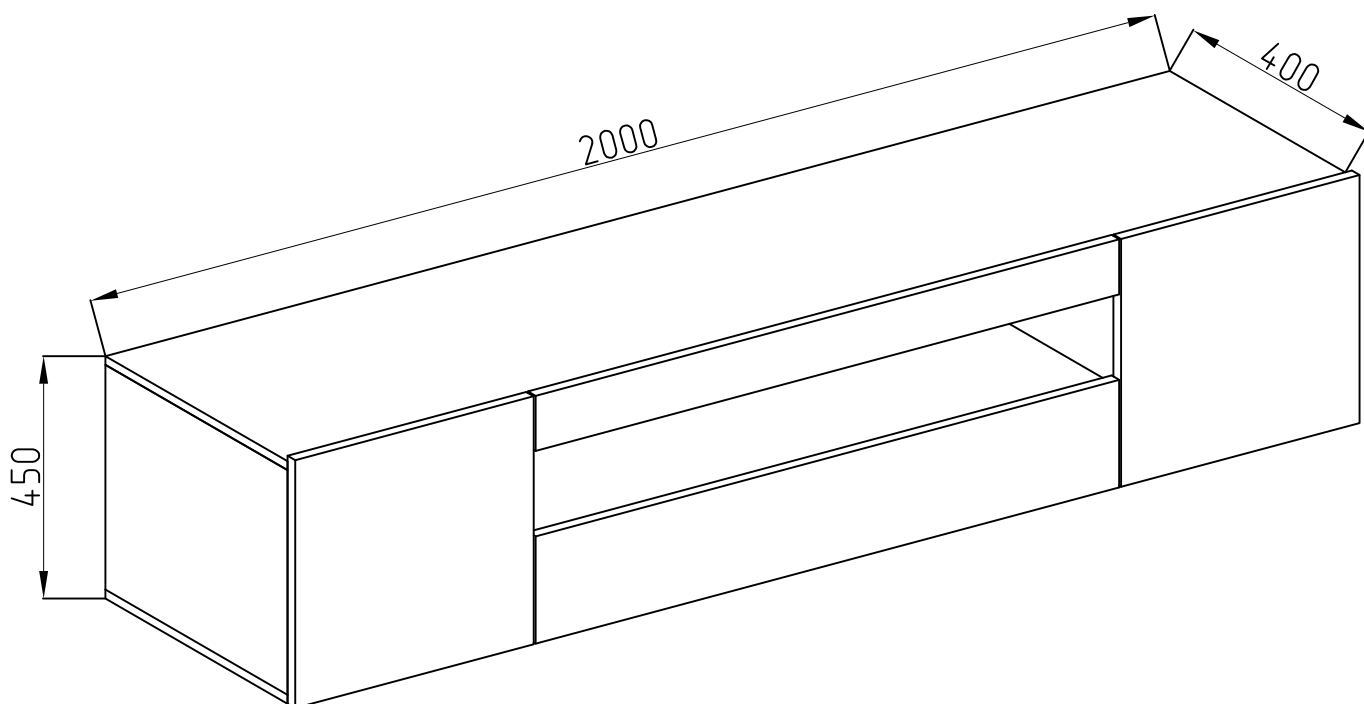

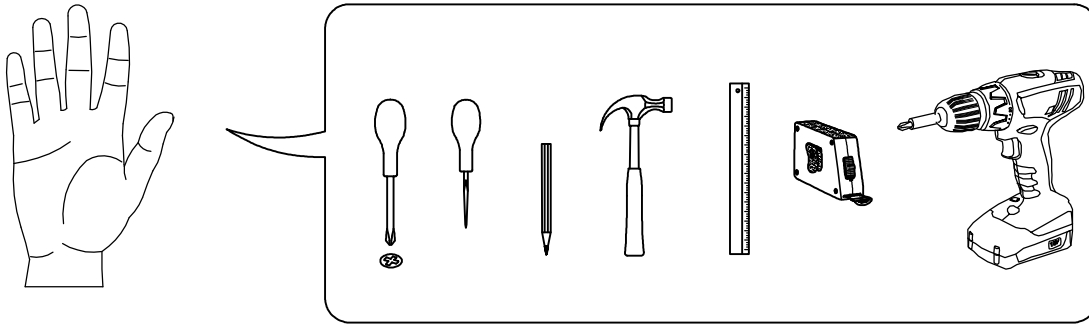

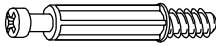



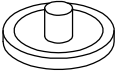

# Lorenzo 2

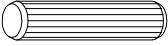
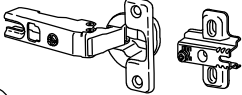
---

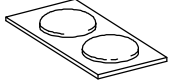

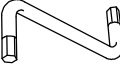
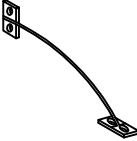





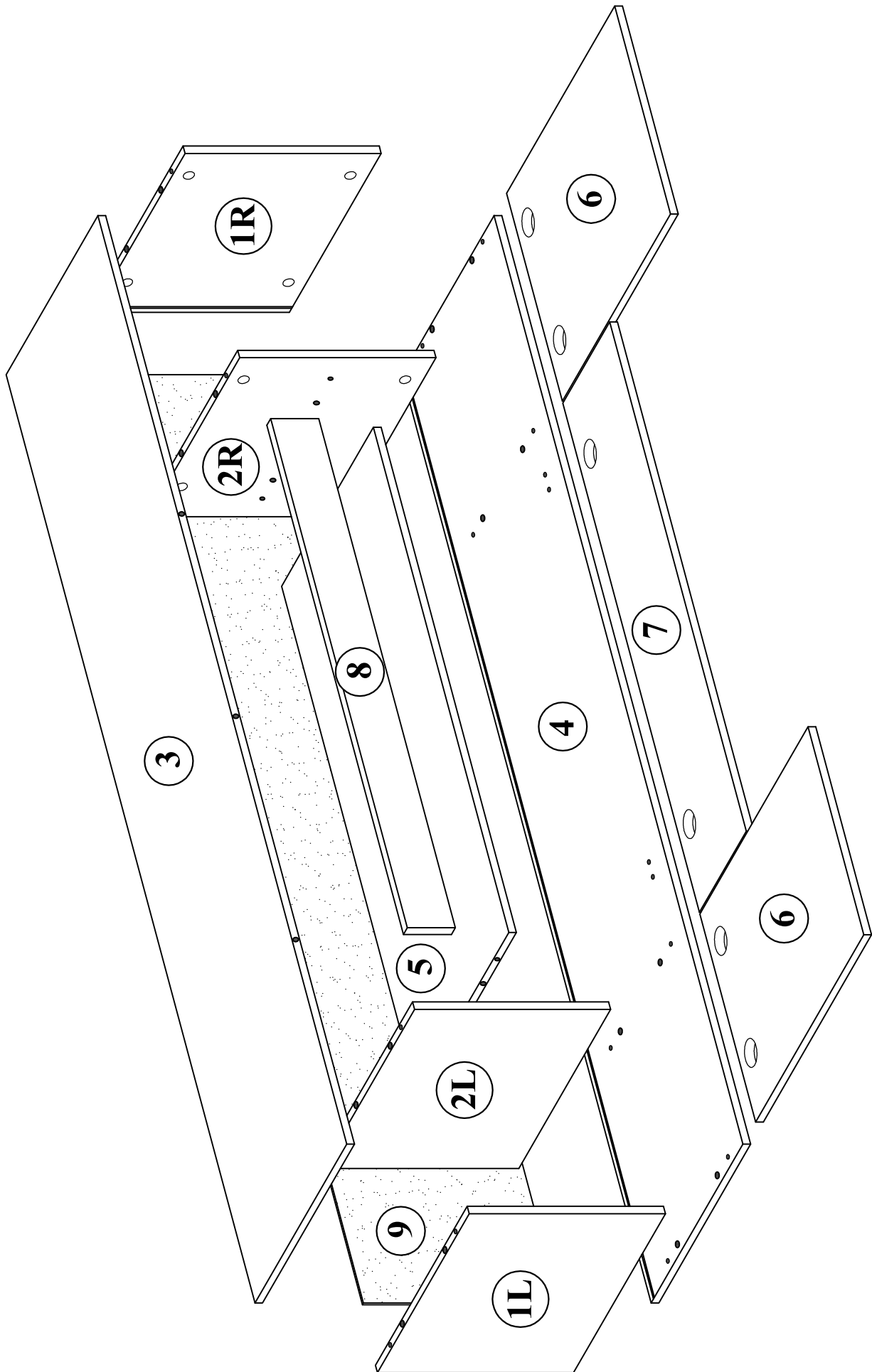

 (C1) 6*43mm x23	 (D1) 15/16 x23	 (D) $\phi$ 20mm x23
 (K5) x8	 (A1) 8*30mm x20	 (L1) x6
 (E10) 4*16mm x12	 (F2) 6,3*13mm x12	 (U6) x6
 (H2) x12	 (R4) N°4 x1	 (S8) x2
 (E2) 3*15mm x8		

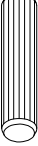
<b>No</b>	<b>a*b</b>	<b>x</b>
1	408x382	2
2	408x368	2
3	2000x382	1
4	2000x382	1
5	1086x368	1
6	450x448	2
7	195x1097	1
8	100x1097	1
9	1975x417	1

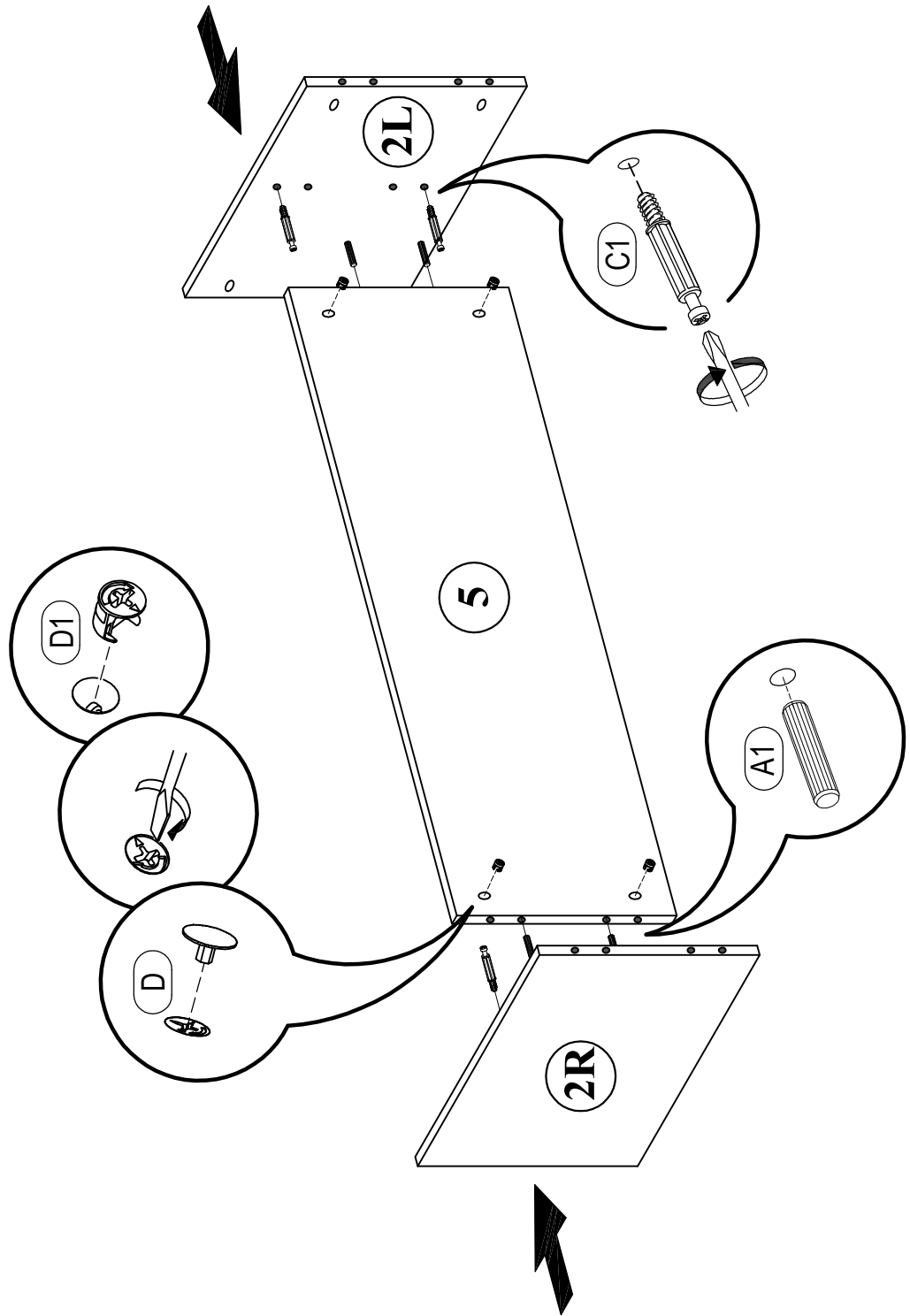



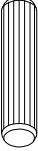

 C1	6*43mm	x4	 D1	15/16	x4	 D	φ20mm	x4	 A1	8*30mm	x4
-------------------------------------------------------------------------------------------	--------	----	-------------------------------------------------------------------------------------------	-------	----	----------------------------------------------------------------------------------------	-------	----	-----------------------------------------------------------------------------------------	--------	----

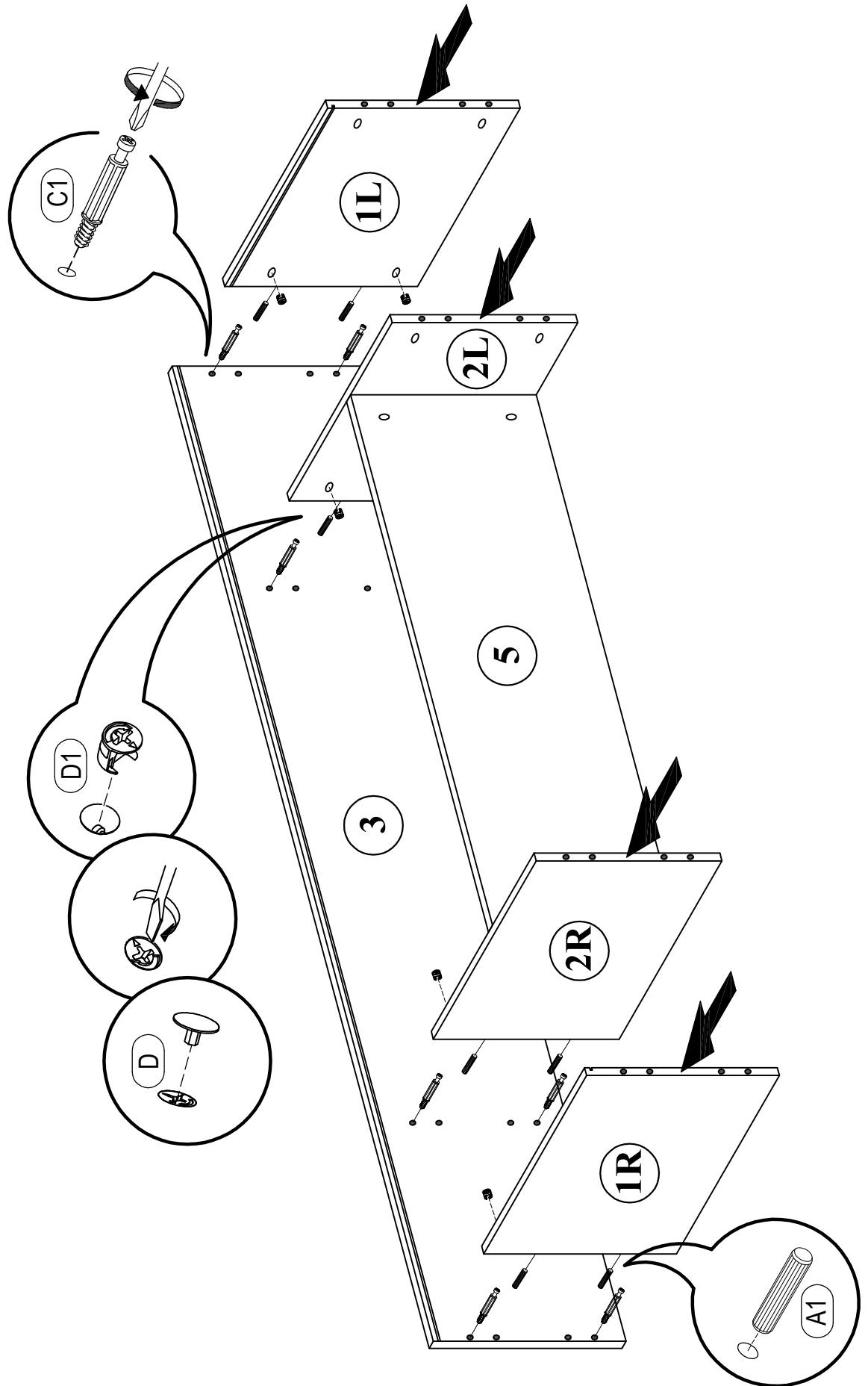

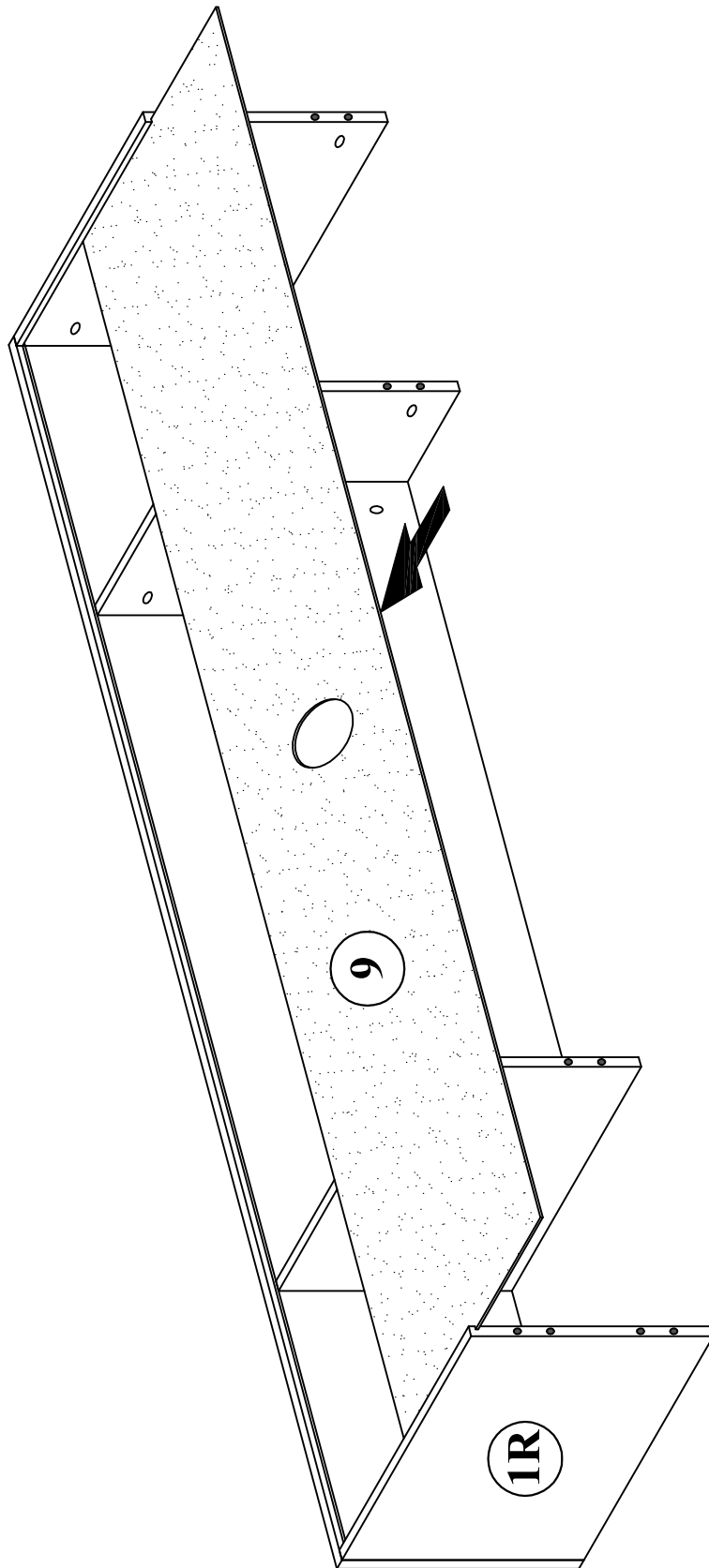
			
C1 6*43mm x8	D1 15/16 x8	D φ20mm x8	A1 8*30mm x8





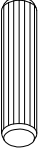

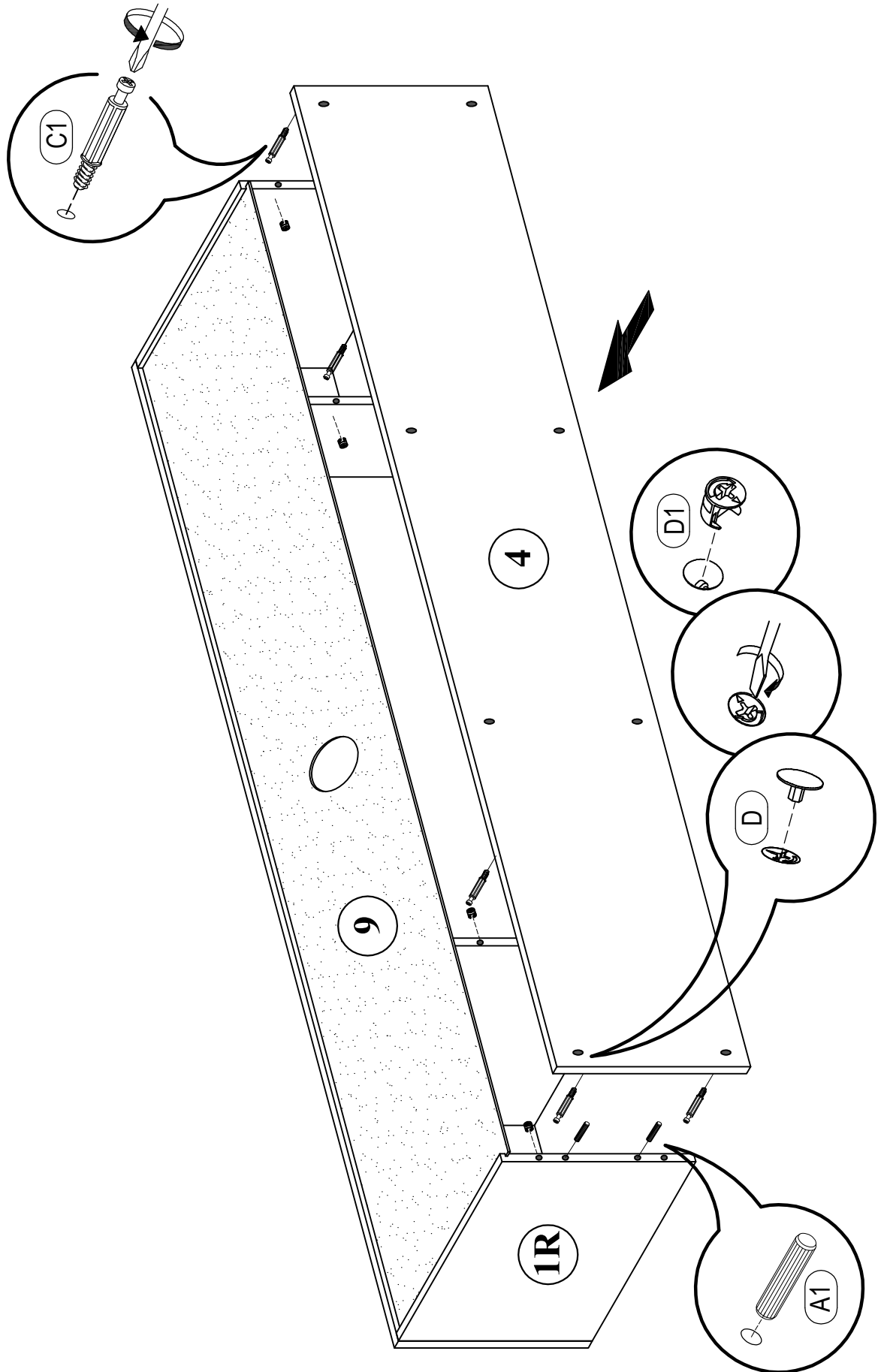
	<b>C1</b>	6*43mm	x8
	<b>D1</b>	15/16	x8
	<b>D</b>	φ20mm	x8
	<b>A1</b>	8*30mm	x8







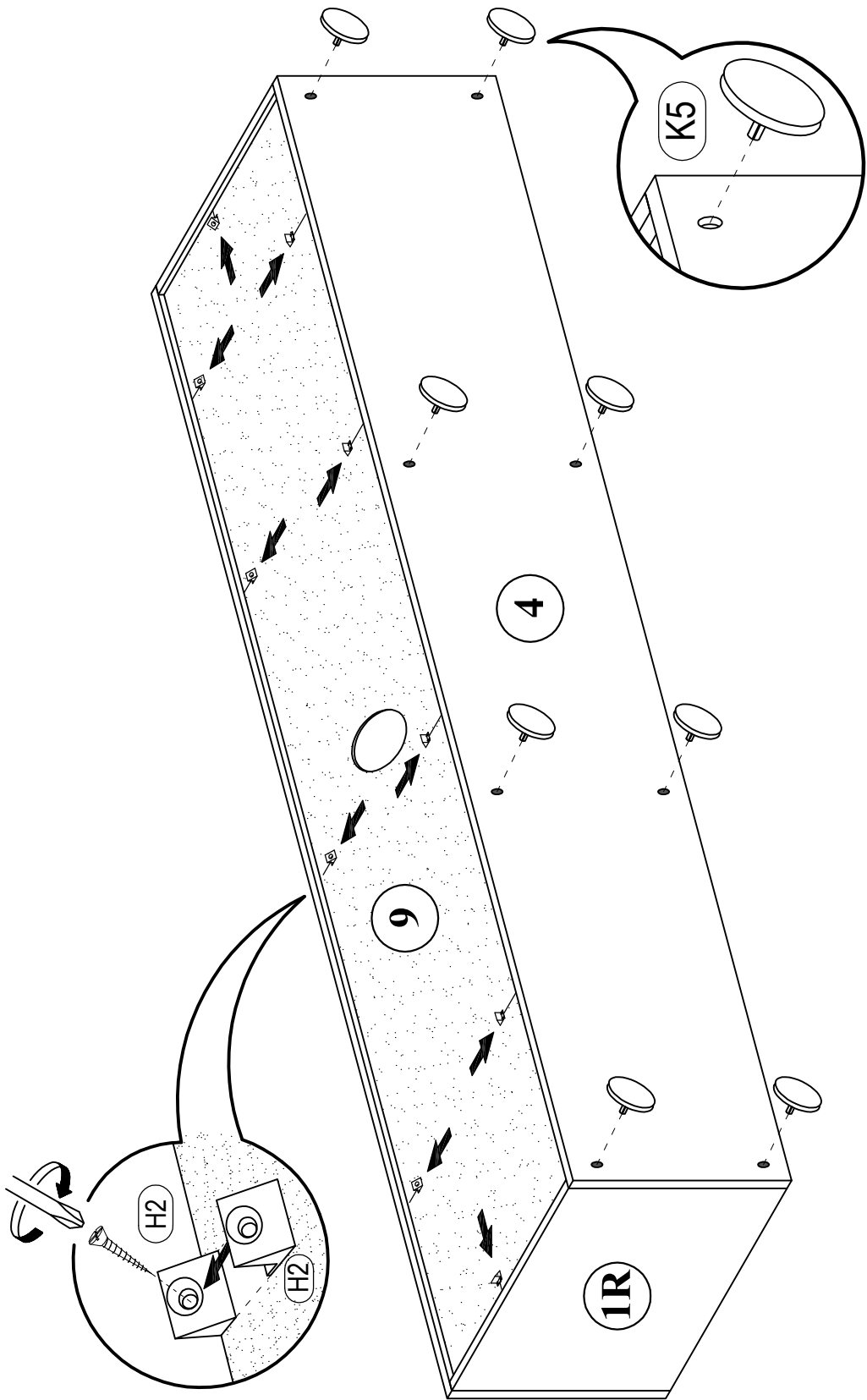

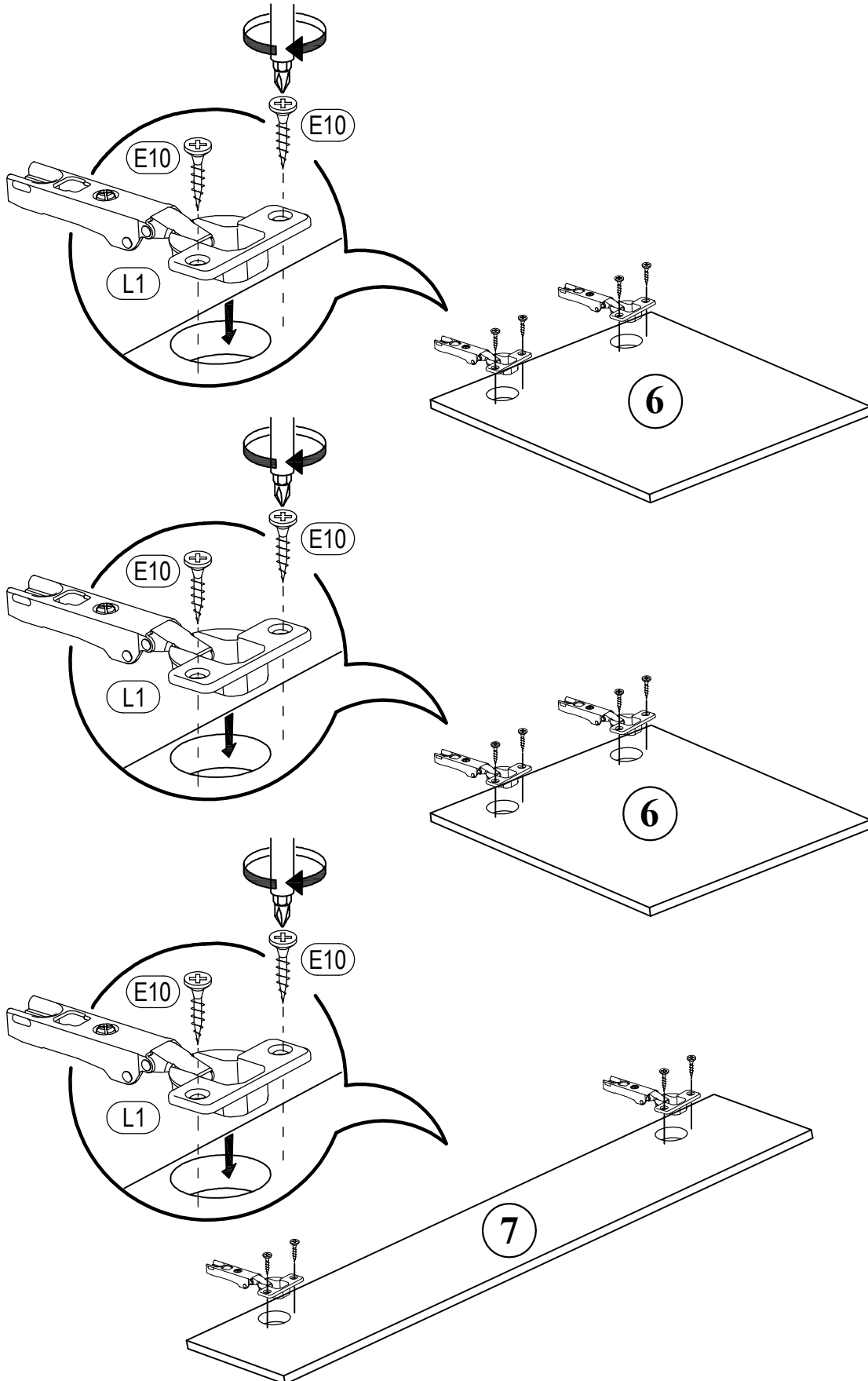
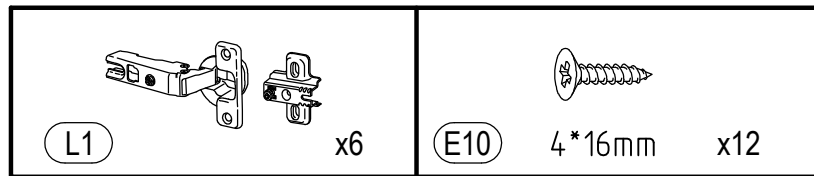

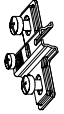
 (K5)	 x8	 (H2) x10
------------------------------------------------------------------------------------------	----------------------------------------------------------------------------------------	--------------------------------------------------------------------------------------------

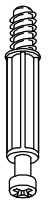

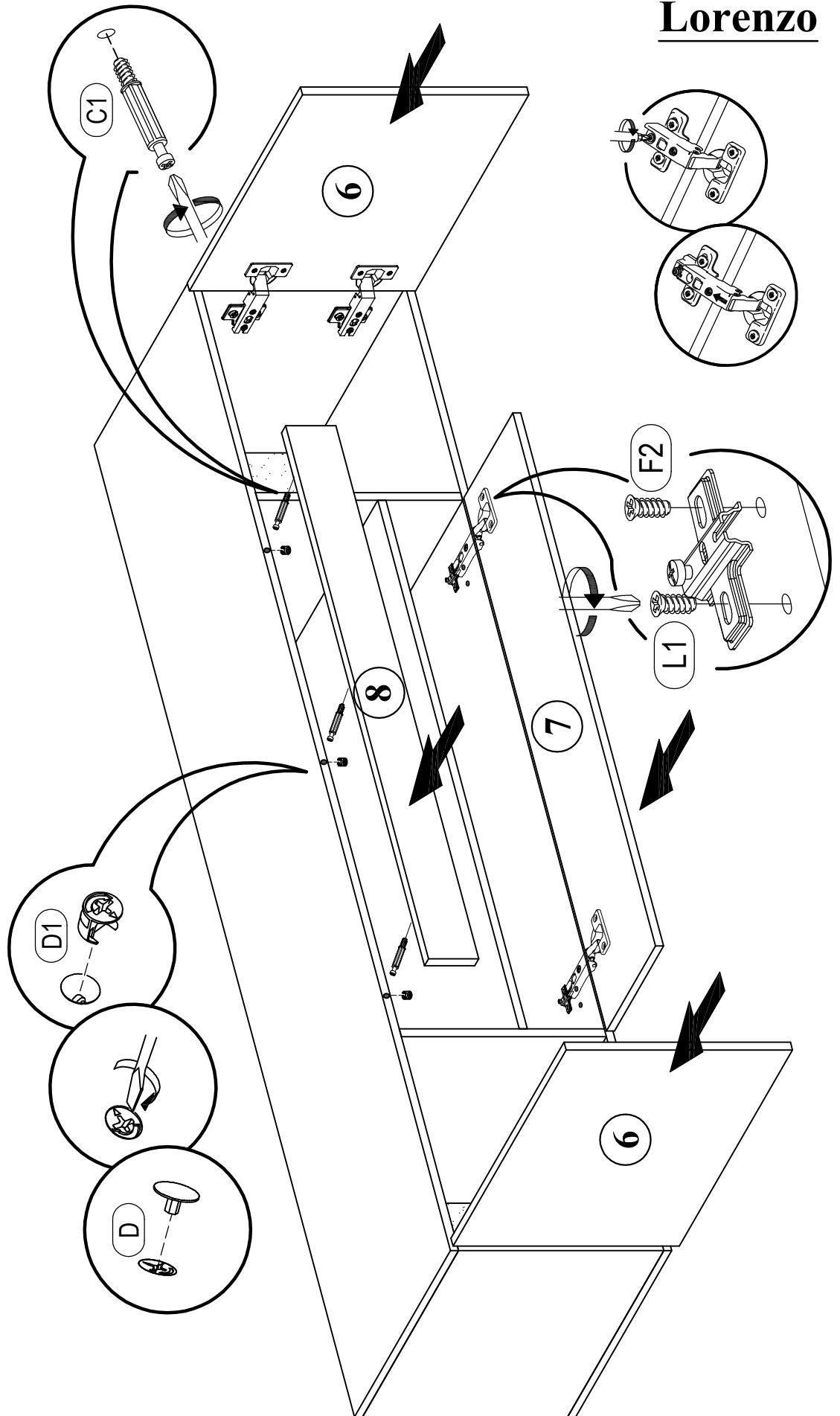

	x6		6,3*13mm	x12		6*4,3mm	x3		15/16	x3		ø20mm	x3
-------------------------------------------------------------------------------------	----	-------------------------------------------------------------------------------------	----------	-----	-------------------------------------------------------------------------------------	---------	----	-----------------------------------------------------------------------------------	-------	----	-----------------------------------------------------------------------------------	-------	----

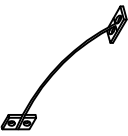
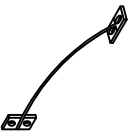

		3*15mm	x8
		x2	
