

# FIONA

---

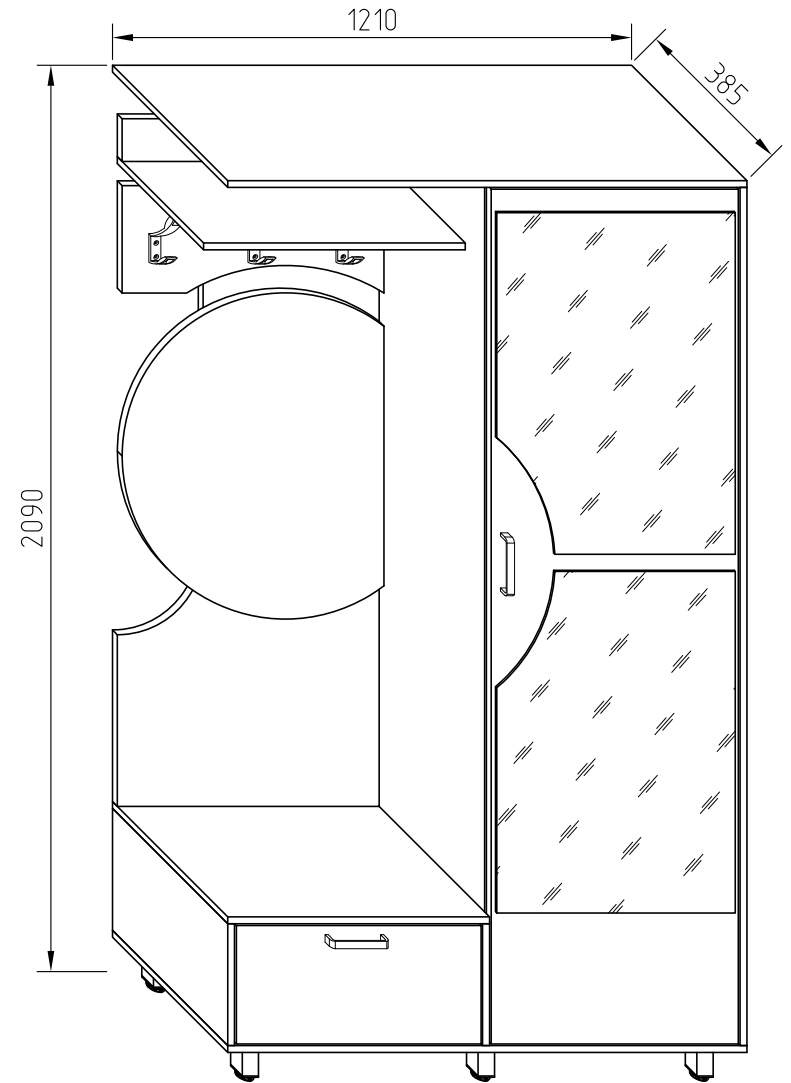

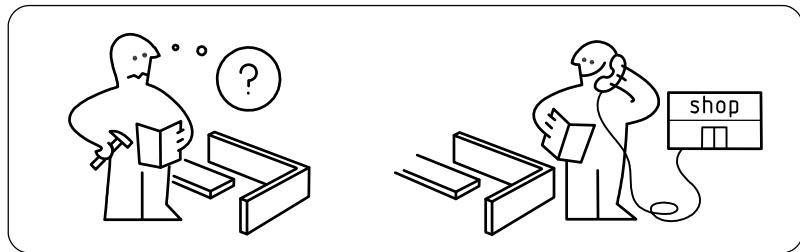

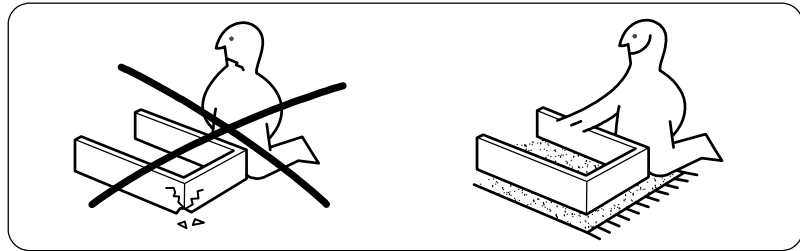
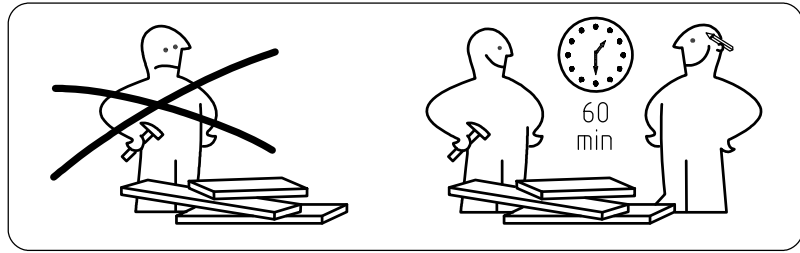
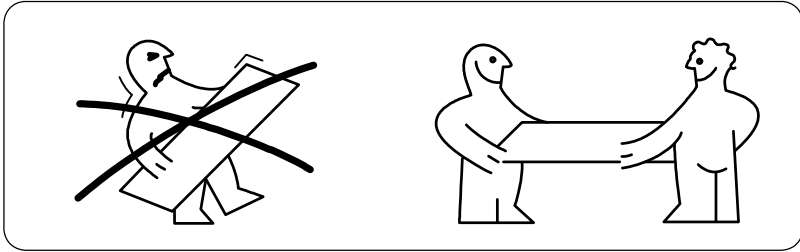
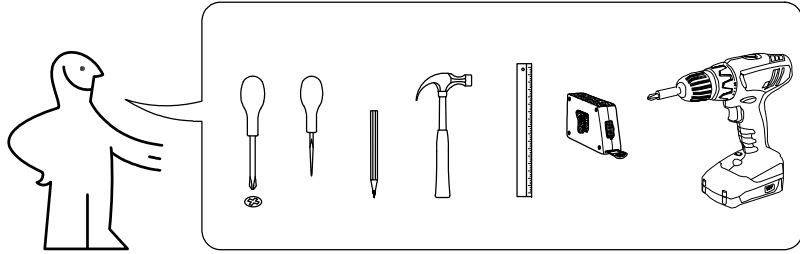
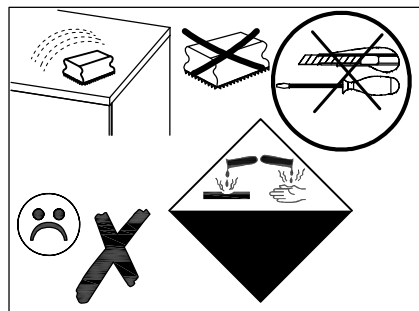
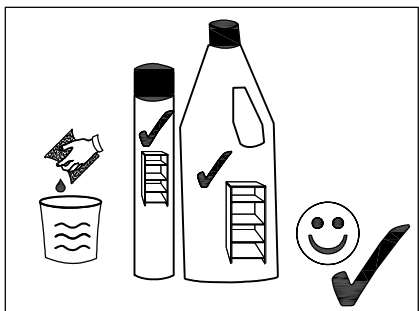
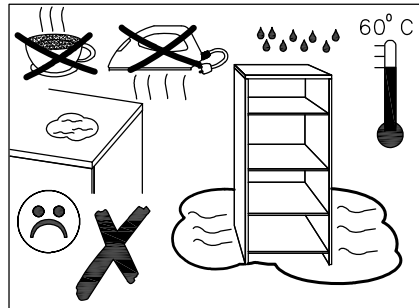
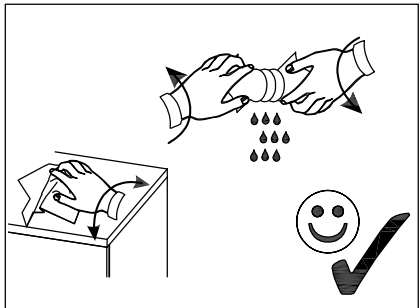
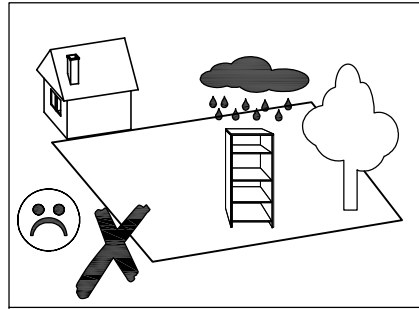
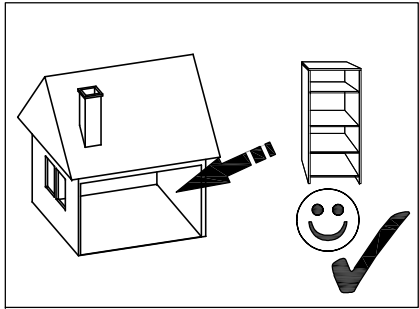
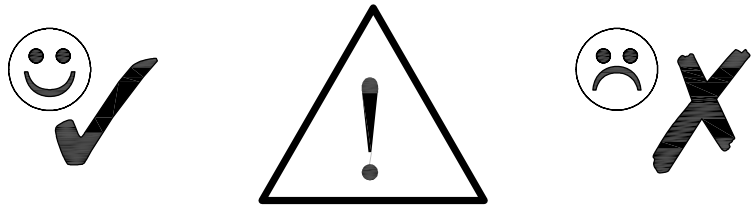

A1 8*30mm x4	B x22	B1 6,3*50mm x39
E3 3*15mm x30	E4 3*20mm x8	E8 4*16mm x16
E10 4*30mm x6	F1 6,3*13mm x12	H1 M 4 x4
I21 128 x2	J1 5*16mm x1	K10 H-60mm x6
L3 x6	N4 R + L x2	N6 L- 350 x1
R1 x1	R3 1.4*25mm 0.050kg	R4 N°4 x1
X4 DW08 x3		

№	a*b	x	N°→...	№	a*b	x	N°→...
1L	2000x364	x1	2	9	610x100	x1	1
1R	2000x380	x1	2	10	610x250	x1	1
2L	284x380	x1	4	11	610x760	x1	3
2R	284x380	x1	4	12	1990x576	x1	1
3	610x380	x1	4	13	276x570	x1	4
4	1210x380	x1	2	14	2028x596	x1	1
5	1210x380	x1	2	15	312x606	x1	4
6	568x364	x2	2	16'	796x556	x1	
7	610x284	x1	4	16"	796x556	x1	
8	1700x610	x1	1		x1		4

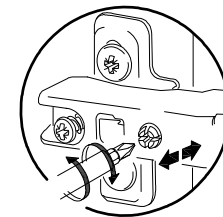
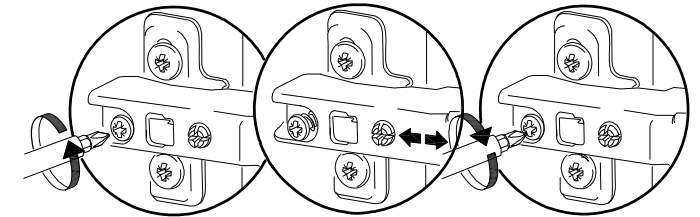
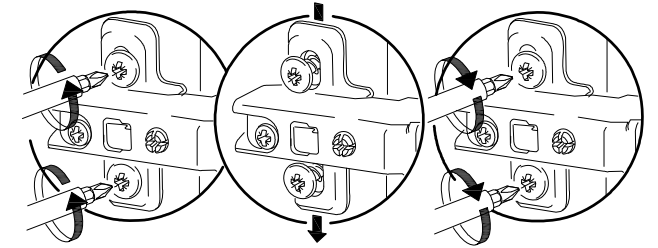
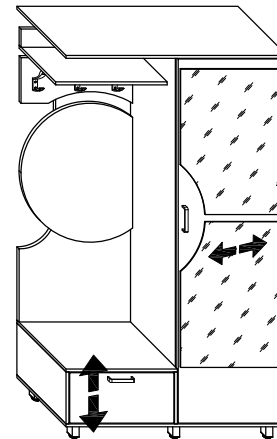
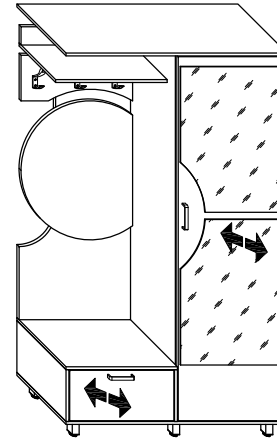
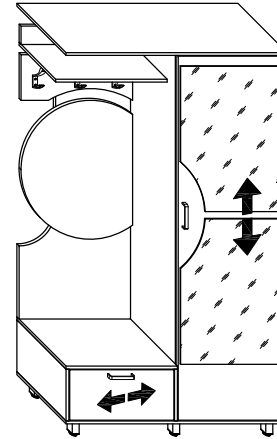
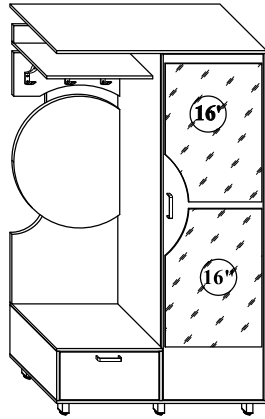
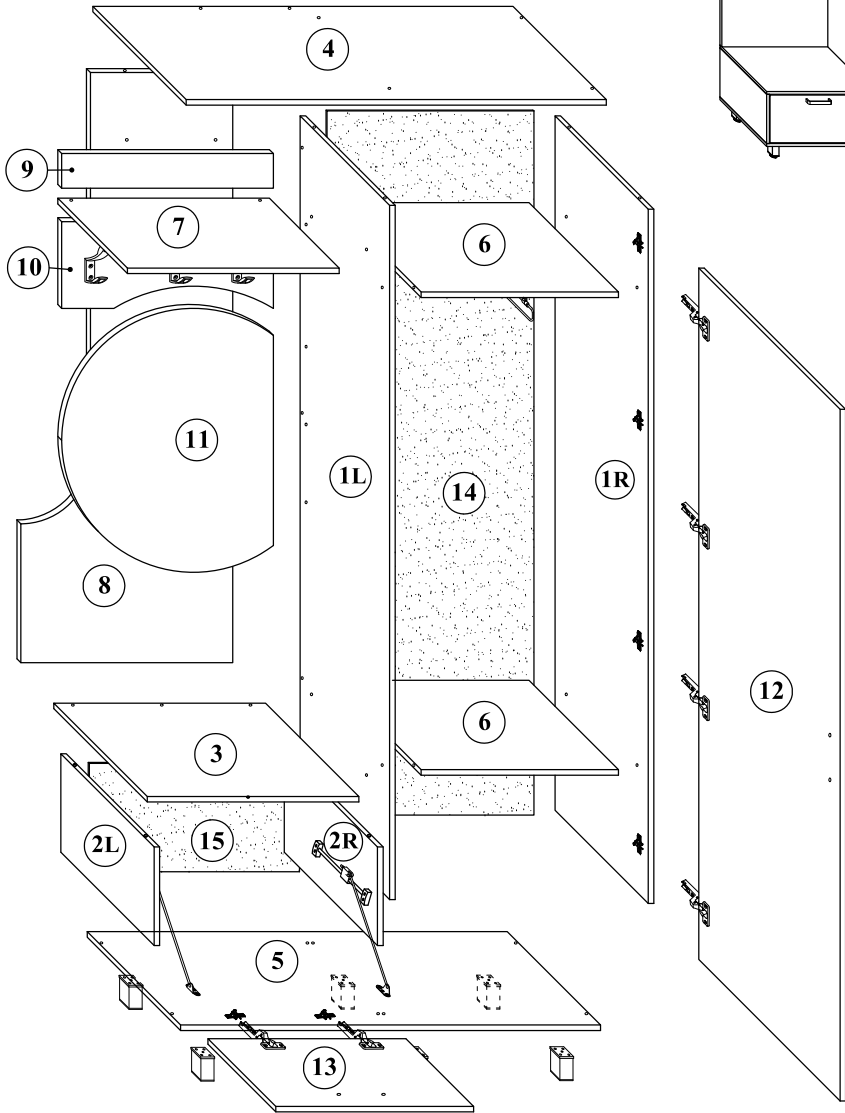

# 16

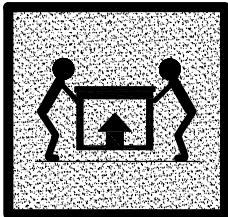
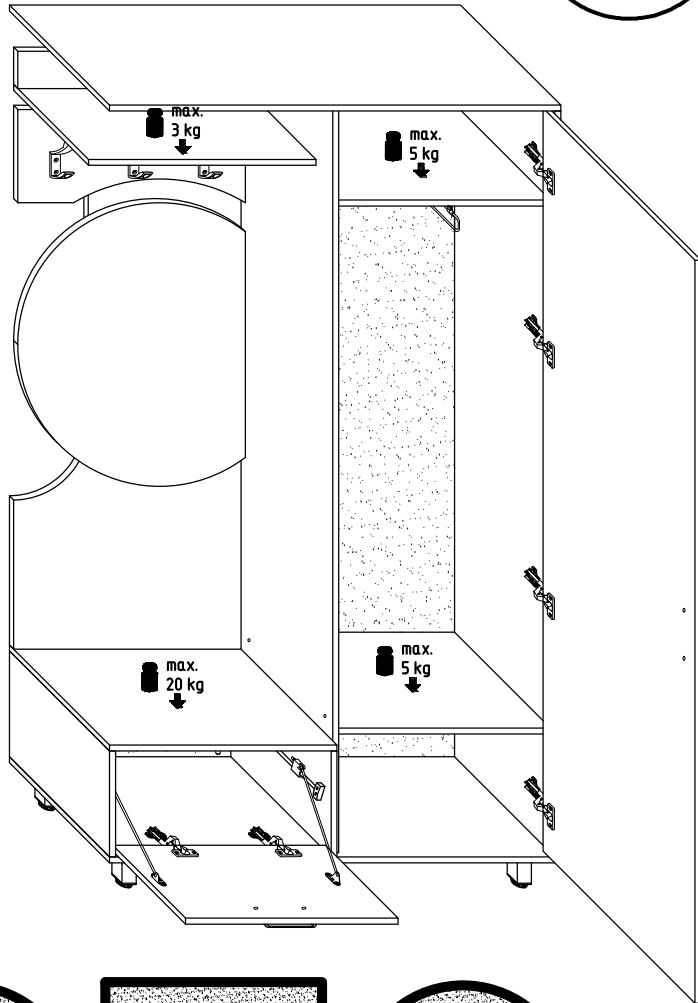
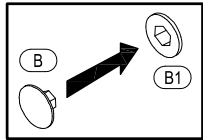
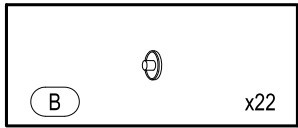

# 1

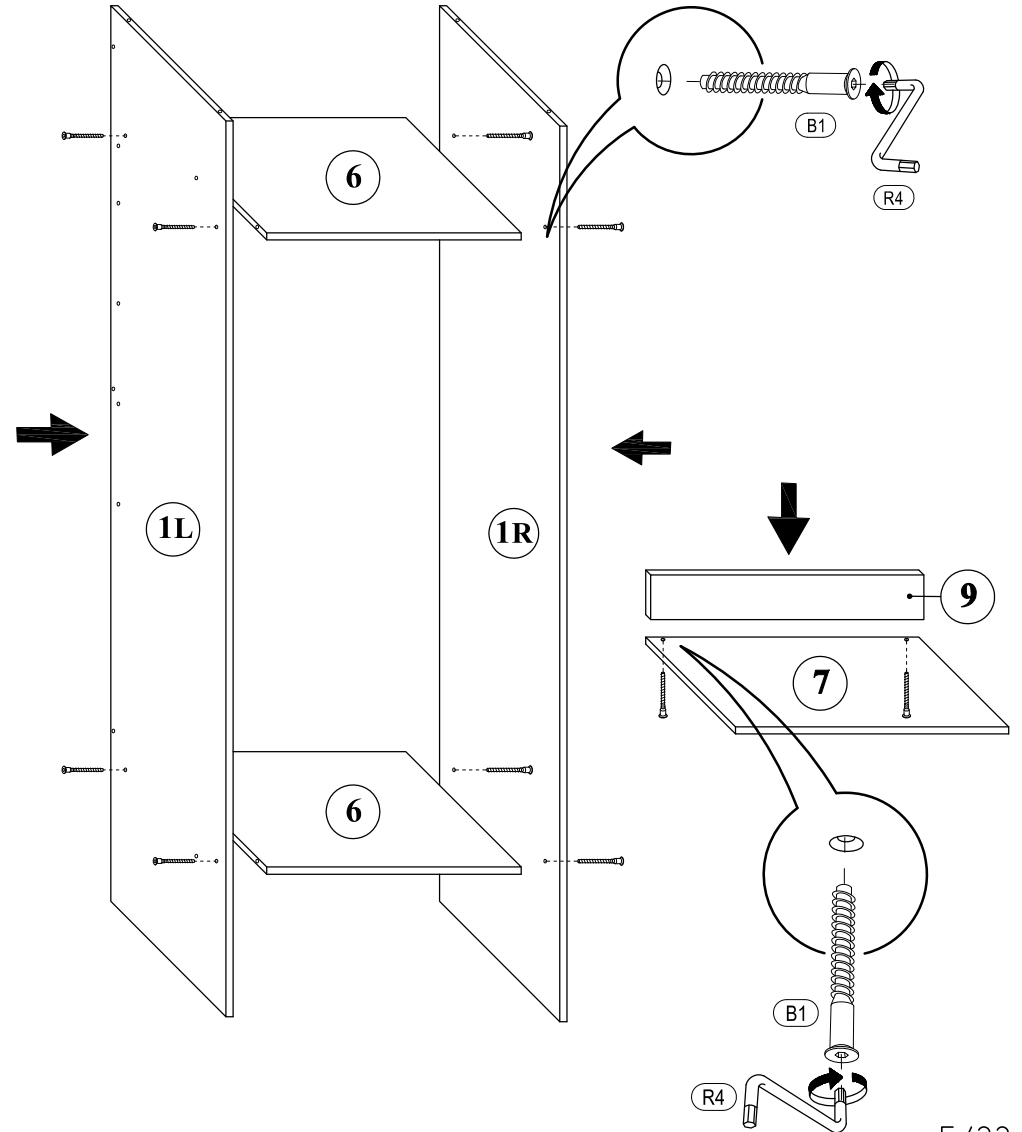
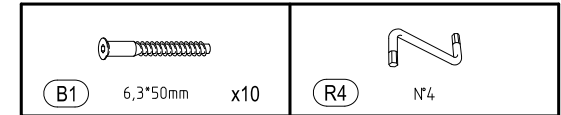

2

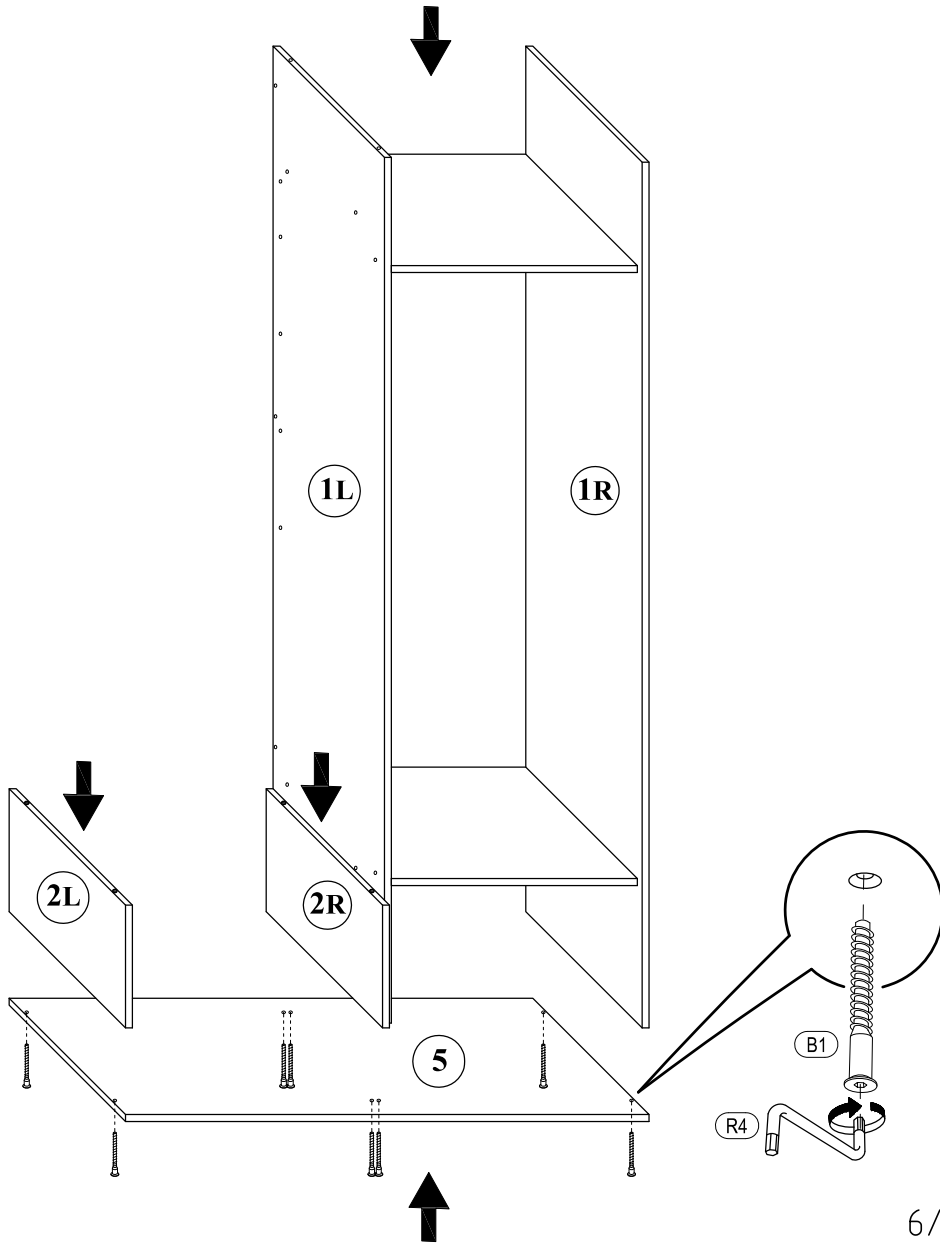

15

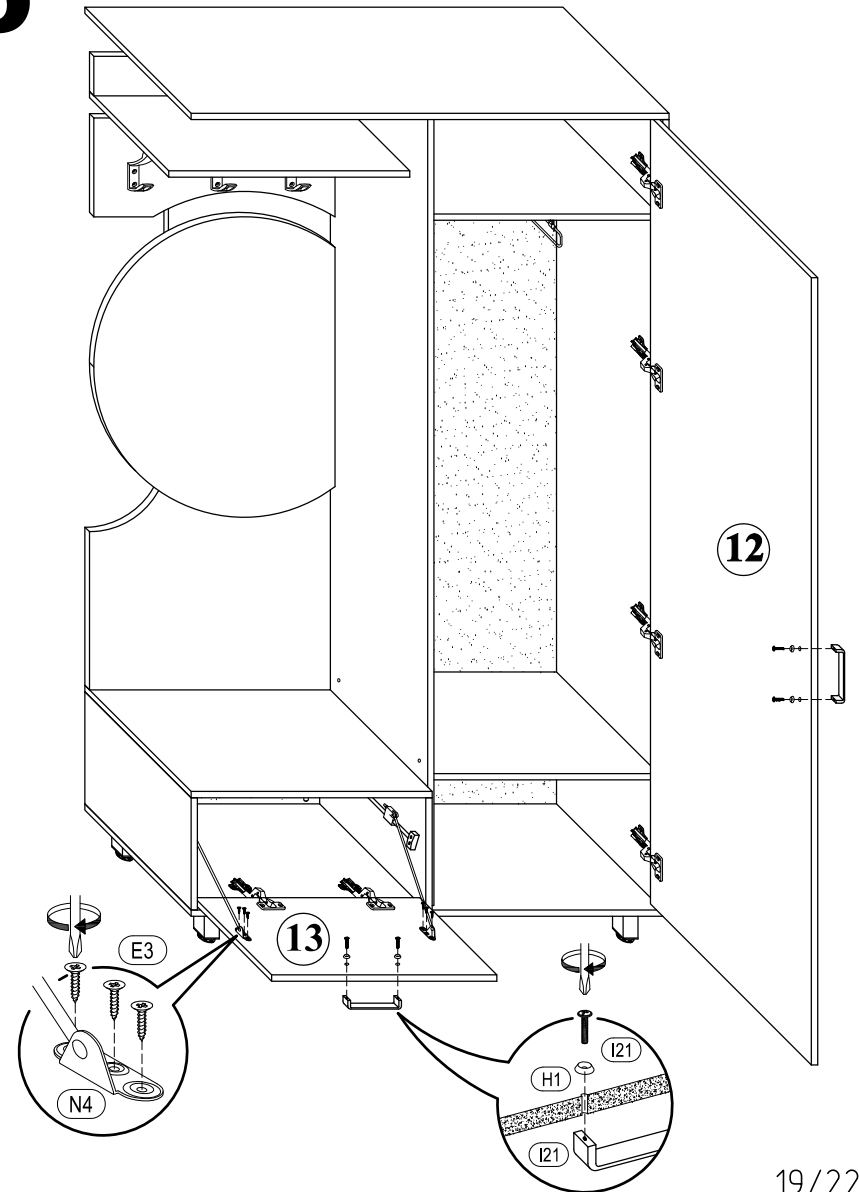

# 14

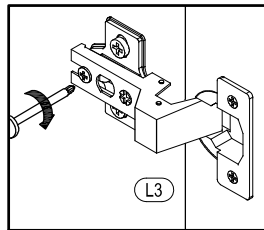
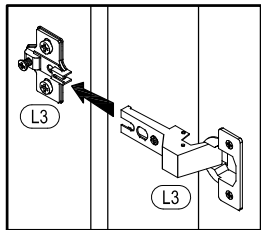
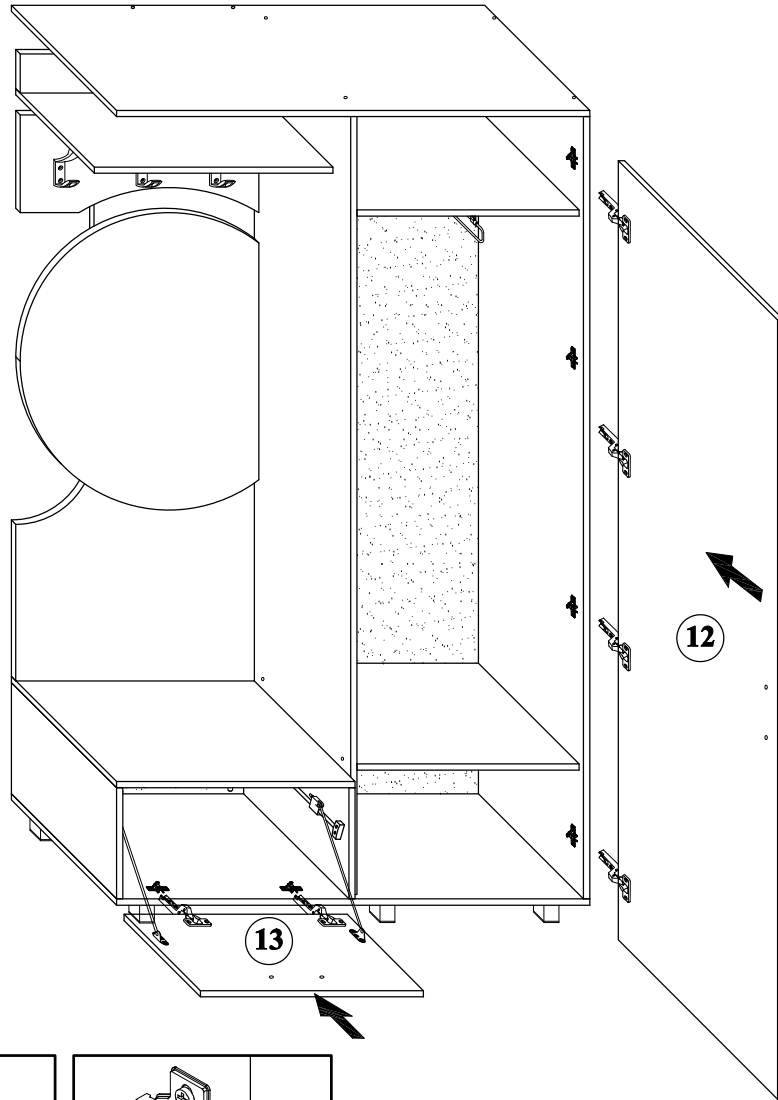

Fiona



18/22

Fiona

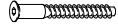
# 3

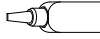
 A1 8*30mm x4	 B1 6,3*50mm x1	 R4 N°4
 R1		

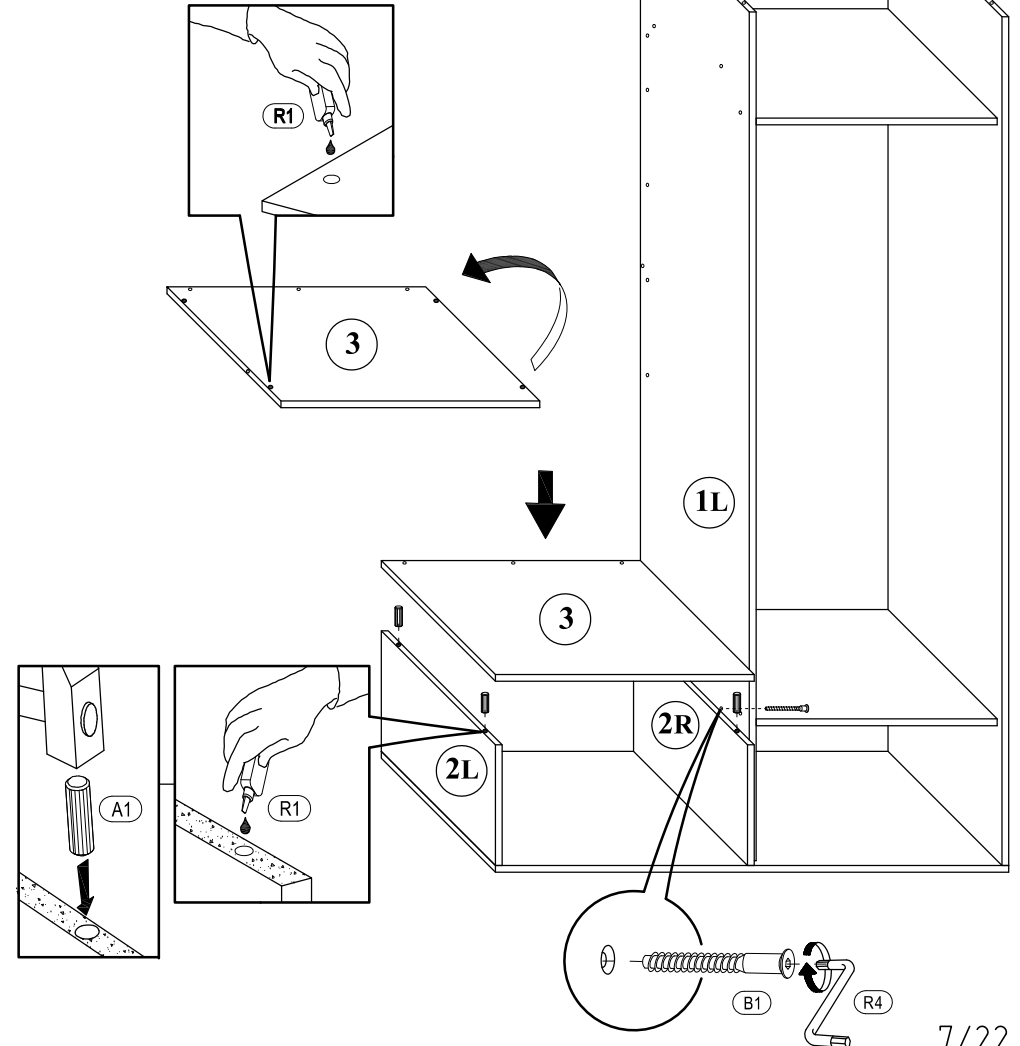

7/22

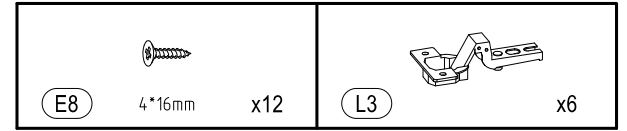
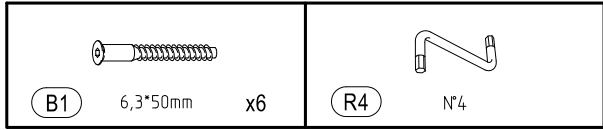

# 13

# 4

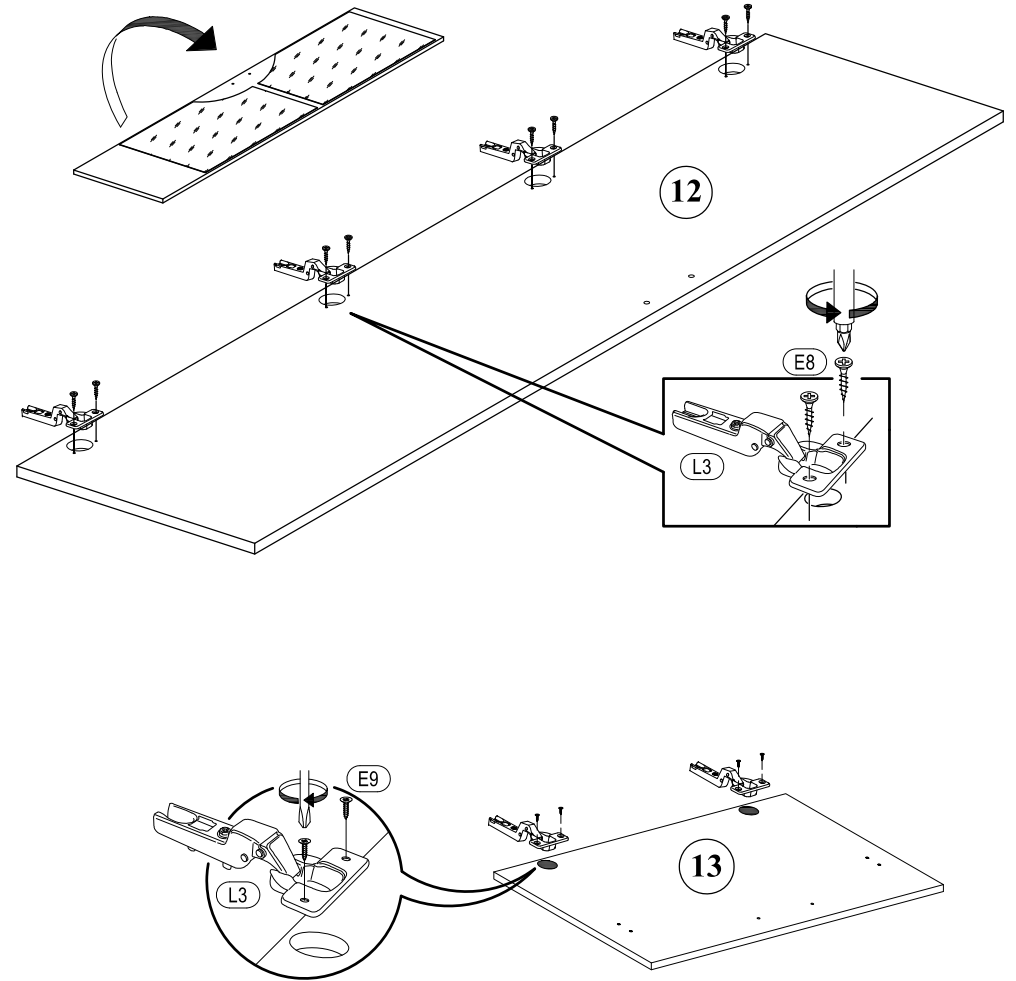
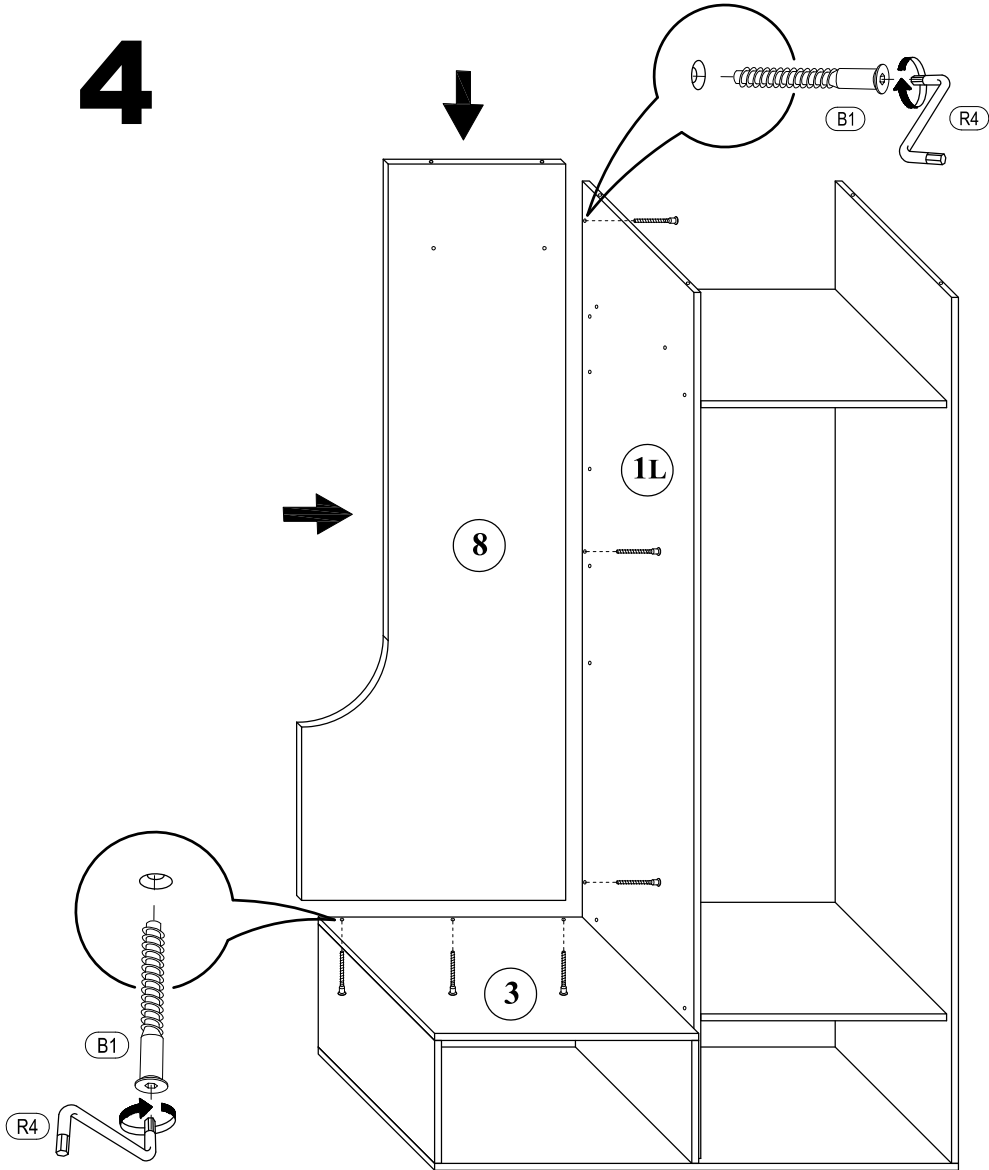



# 12

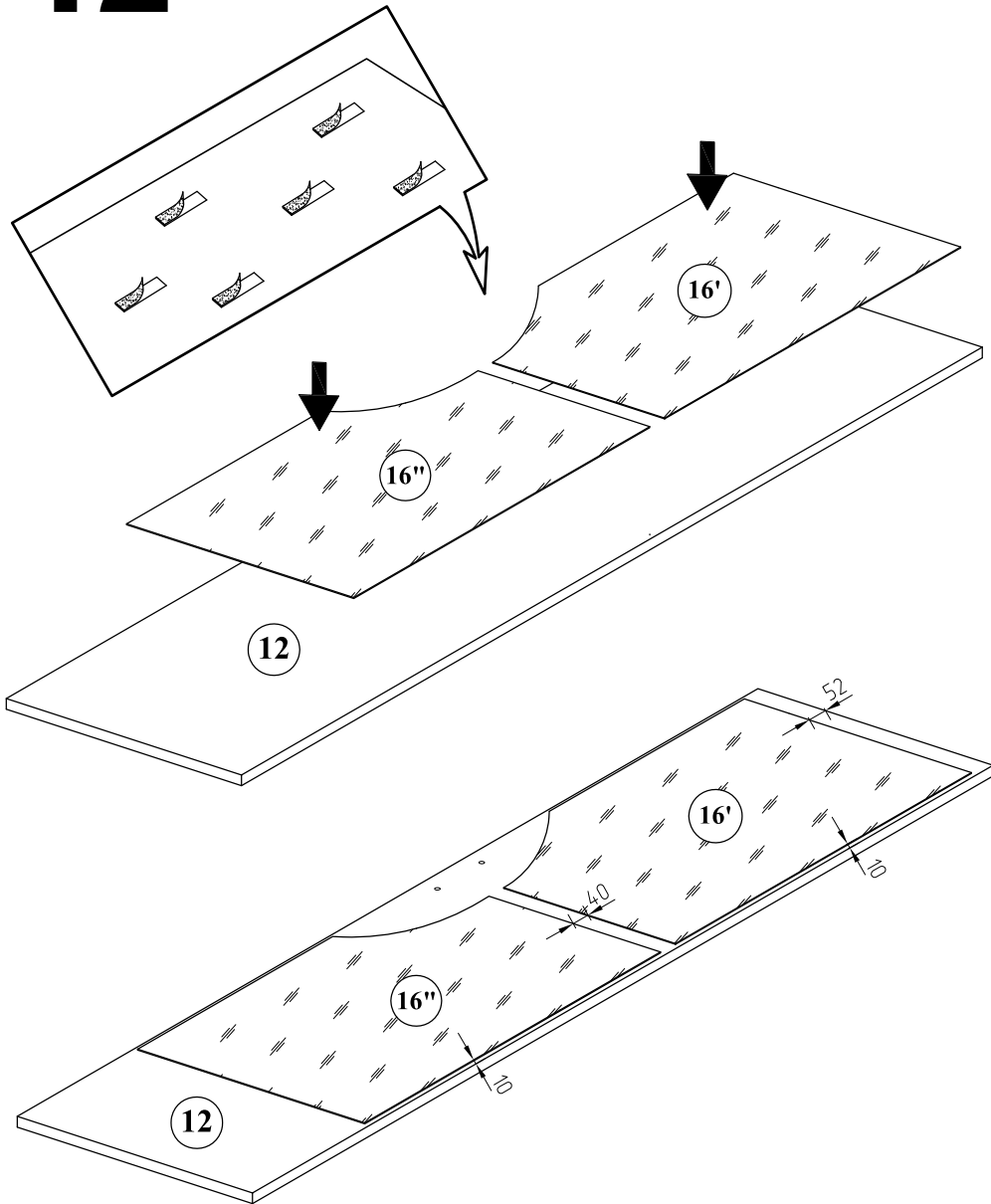

# 5

	
(B1) 6,3*50mm x3	(R4) N°4

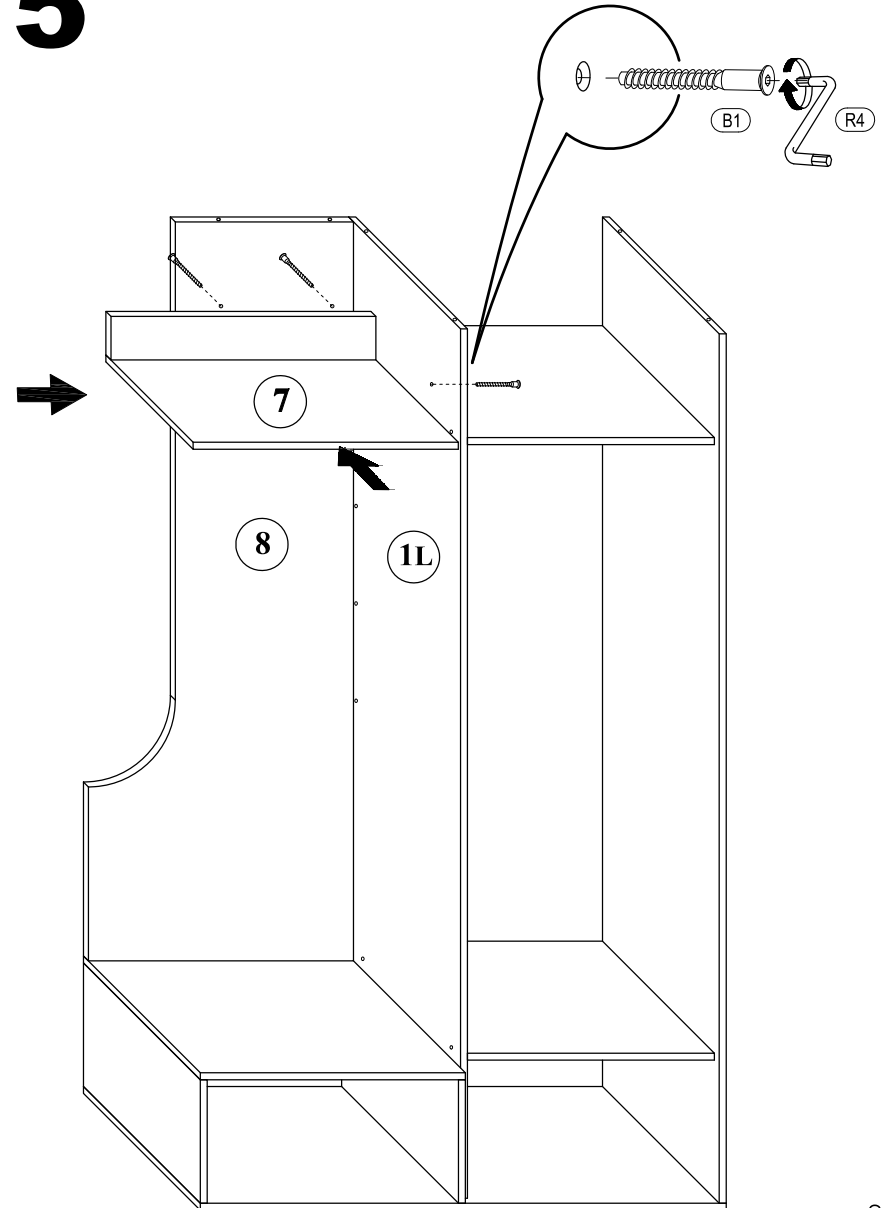

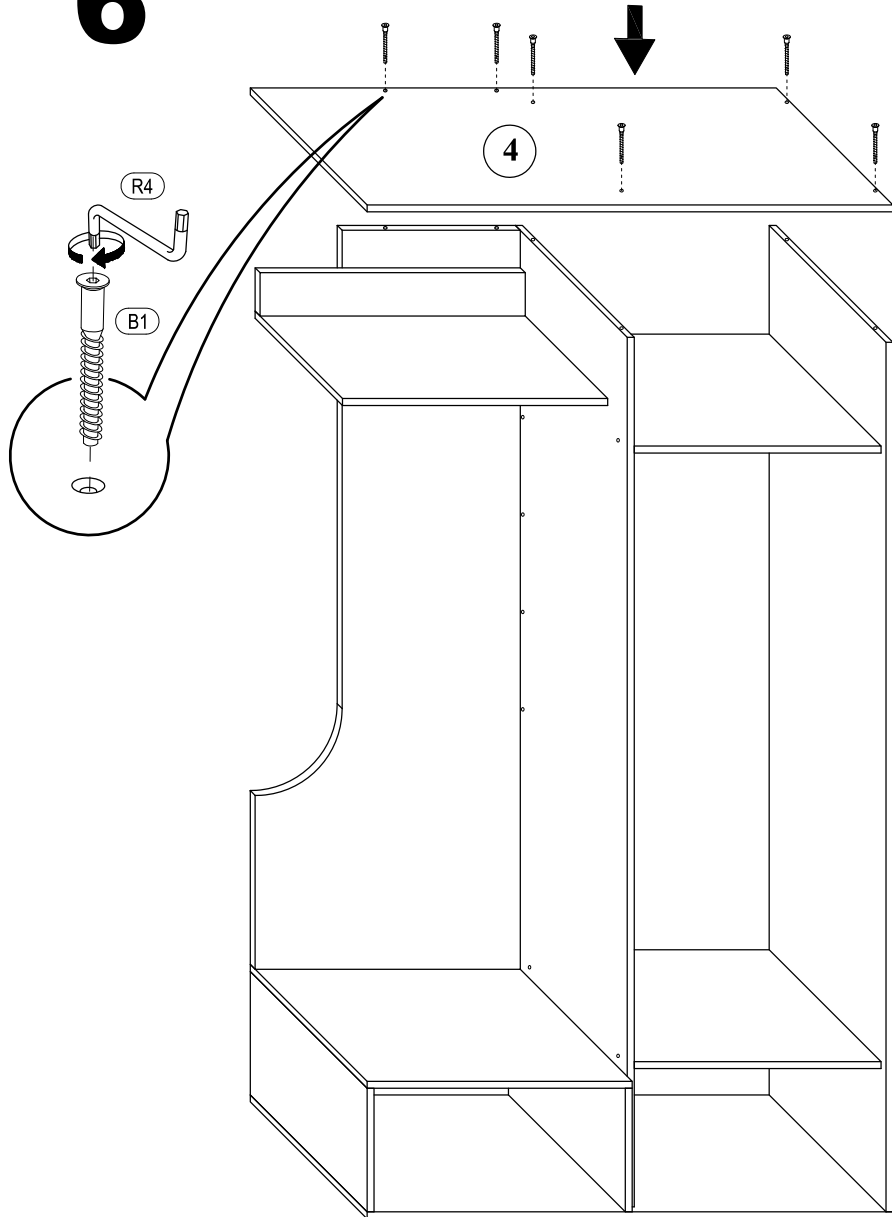
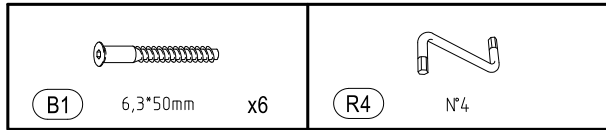

6

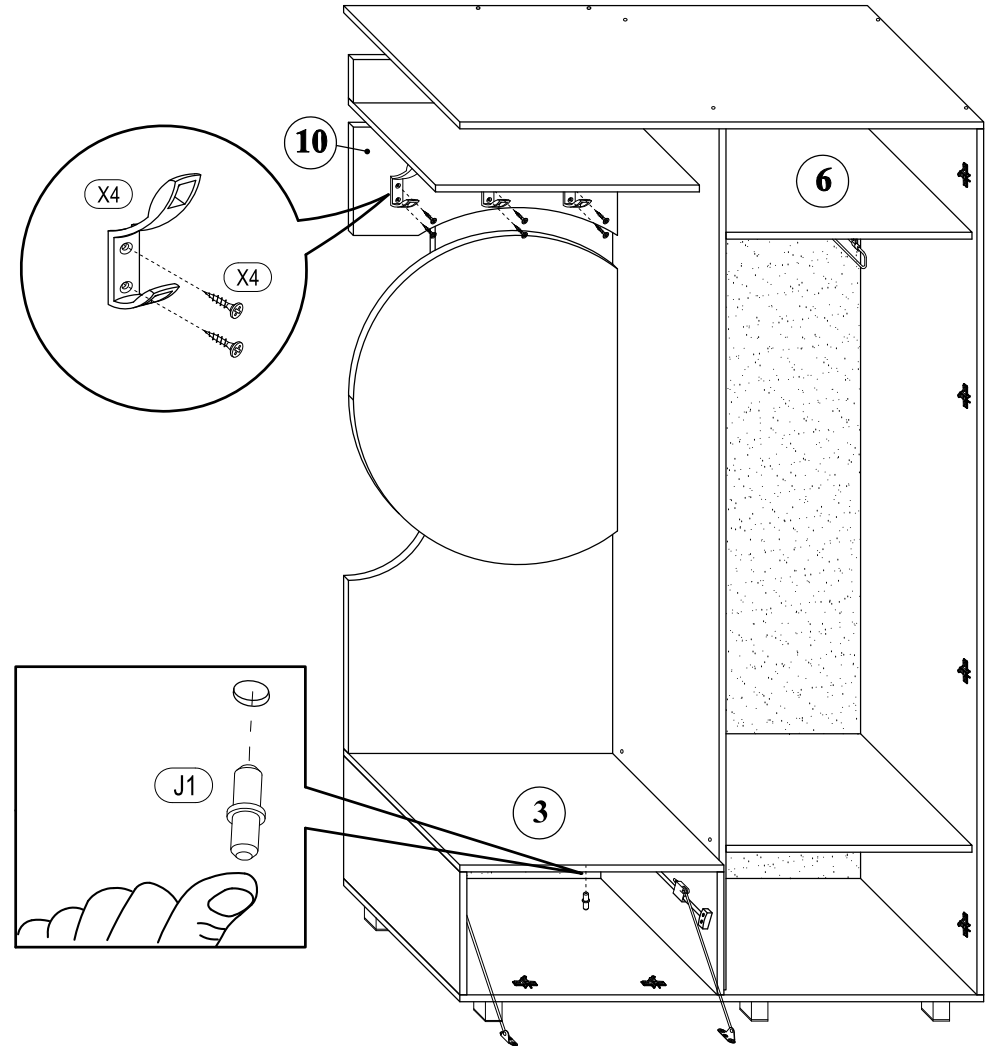
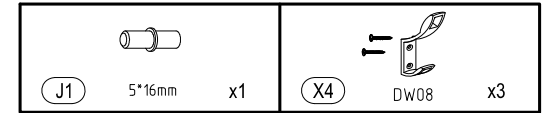

11

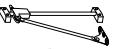

# 10

 E4 3*20mm x8	 F1 6,3*13mm x12	 L3 x6
		 N4 R+L x2

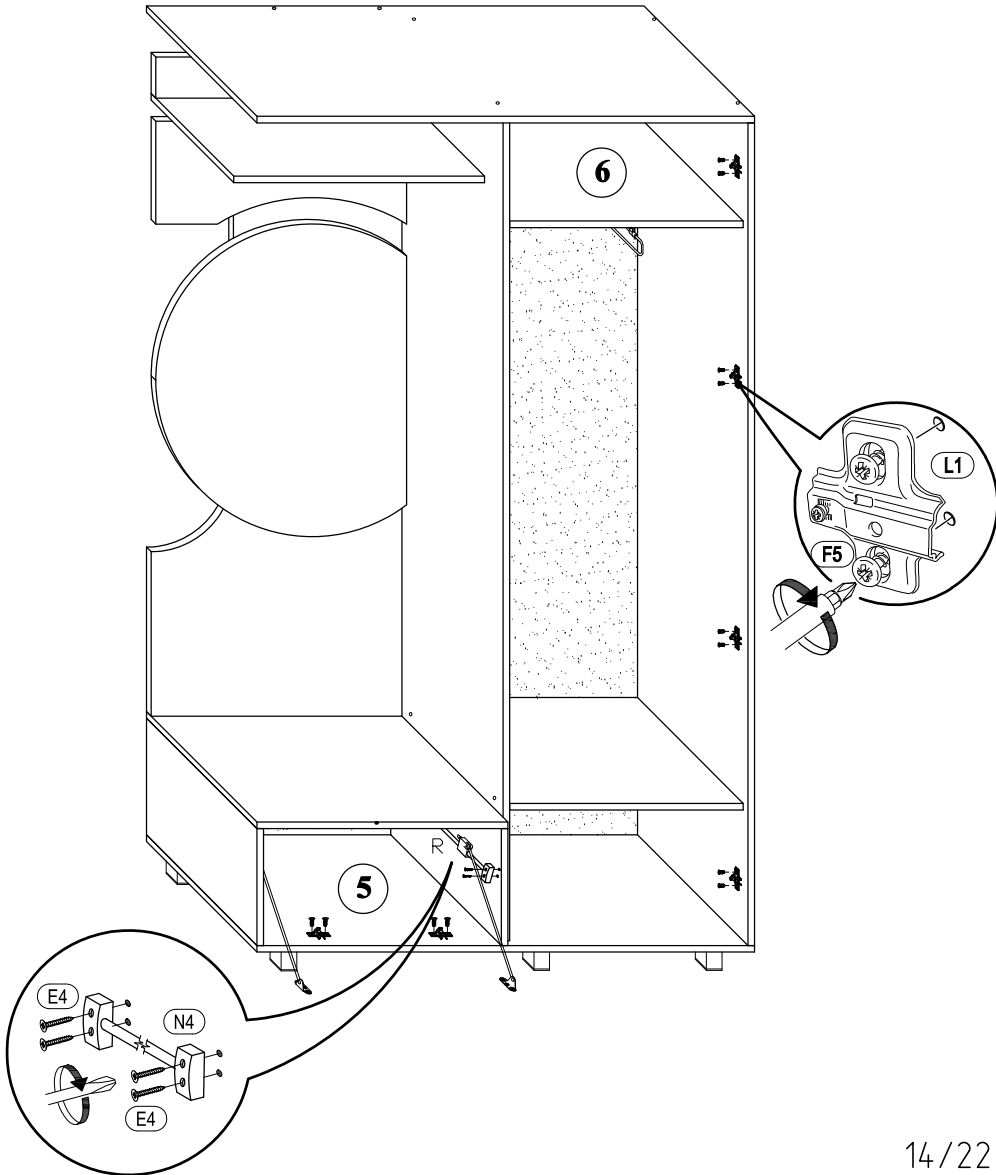

# 7

 R3 14*25mm 0.050kg
--

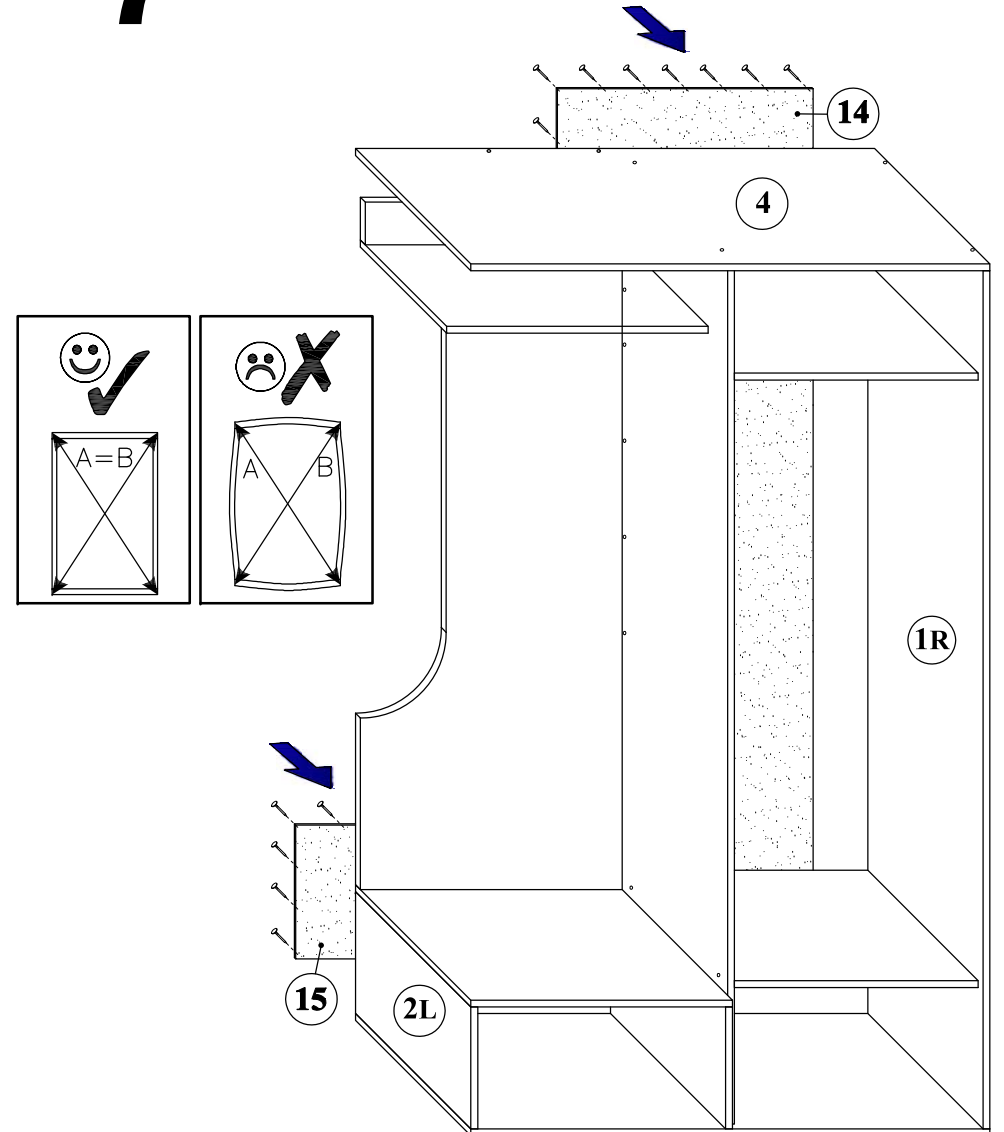



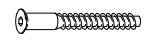
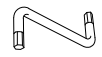

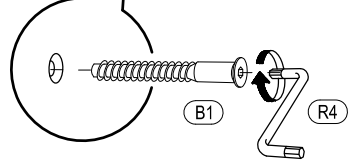
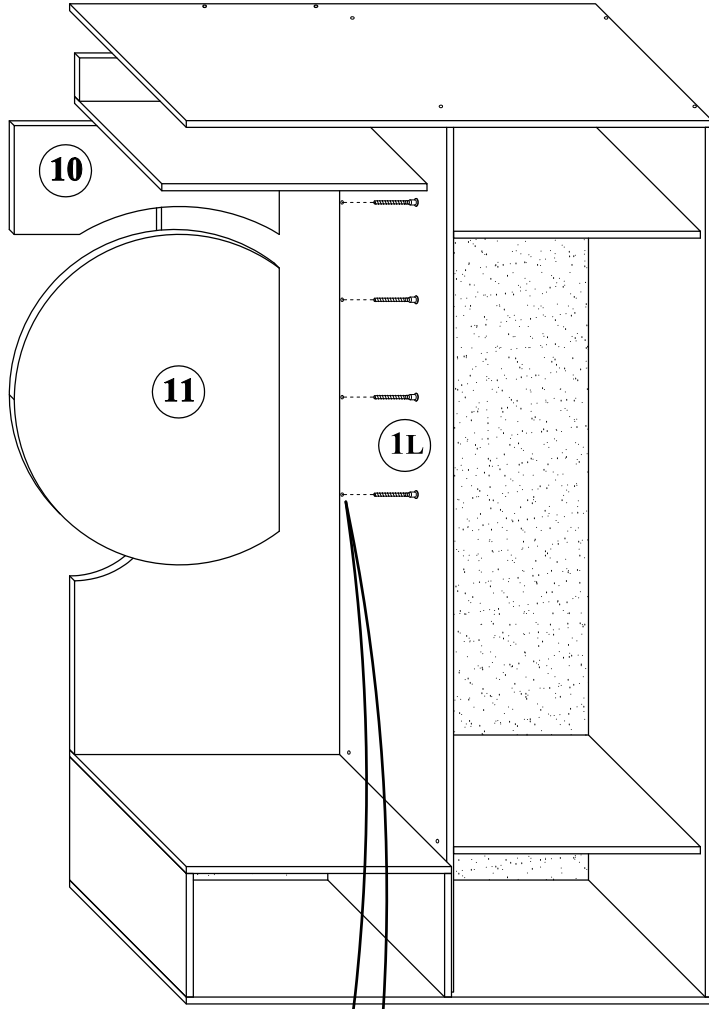
8

 B1 6,3*50mm x6	 R4 N°4
---	---

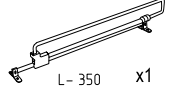

9

 E3 3*15mm x24	 E8 4*16mm x4	 E10 4*30mm x6
 K10 H-60mm x6	 N6 L-350 x1	

