

TWIST

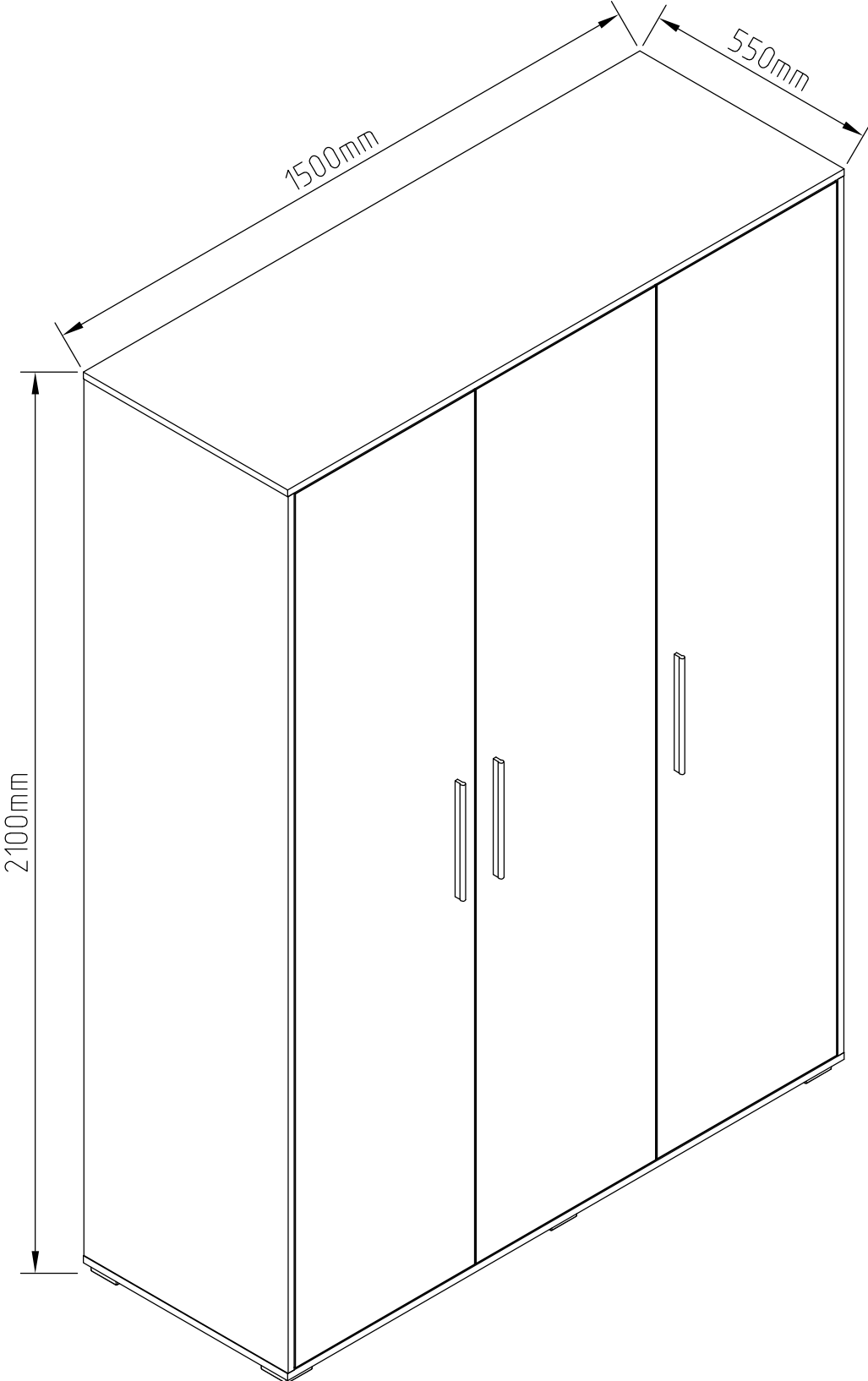







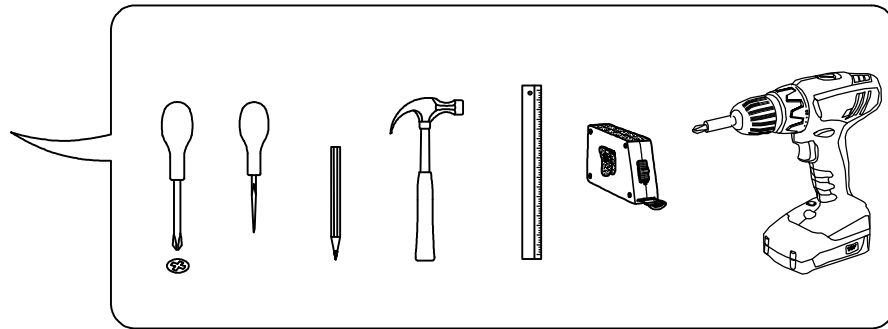
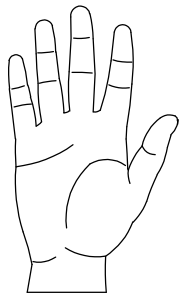

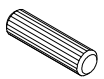

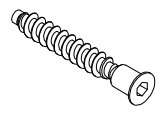
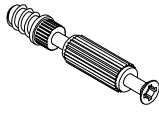

WARDROBE 3D



TWIST

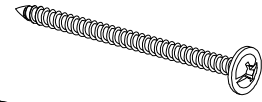

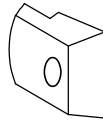
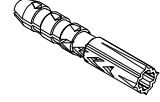
wardrobe 3D

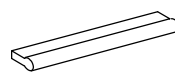
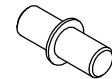
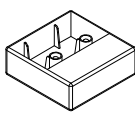
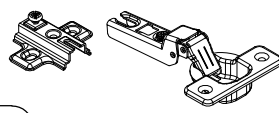
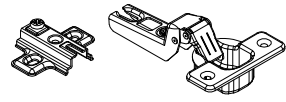
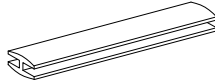
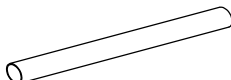
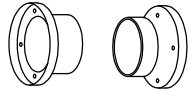

 A1 8*30mm x28	 B x12	 B1 6,3*50mm x12
 C1 6*43mm x20	 D ϕ 20mm x20	 D1 15/16 x20
 E4 3*15mm x20	 E6 3,5*16mm x36	 E14 4*25mm x9
 E16 4*35mm x12	 E-2 4,2*16mm x6	 E-5 4,2*65mm x1
 F4 6,3*13mm x30	 H3 x16	 H5 8*50mm x1
 H7 x1	 I9 x3	 J1 5*16mm x8
 K4 x6	 L2 x5	 L3 x10
 O8 L-2042 mm x1	 P1 ϕ 25 L-962 x1	 P3 R-11M/25 x2

TWIST

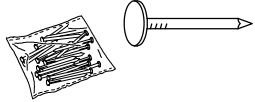
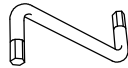
wardrobe 3D

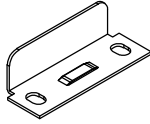
 R3 1.4*25mm 0.080kg	 R4 N°4 x1	 U3 x6
 V2 x2		

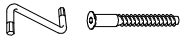
No	a*b	x	N°→...
1L	2044x550	x1	1/3
1R	2044x550	x1	1/3
2	2044x530	x1	1/3
3	1498x550	x1	2/3
4	1498x550	x1	2/3
5	965x522	x2	2/3
6	483x530	x2	2/3
7	482x520	x2	2/3
8	965x150	x1	2/3
9L	2038x484	x1	3/3
10R	2038x484	x1	3/3
11R	2038x484	x1	3/3
12	2072x493	x2	1/3
13	2072x503	x1	1/3
14	1918x364	x1	
		x1	2/3

TWIST
wardrobe 3D

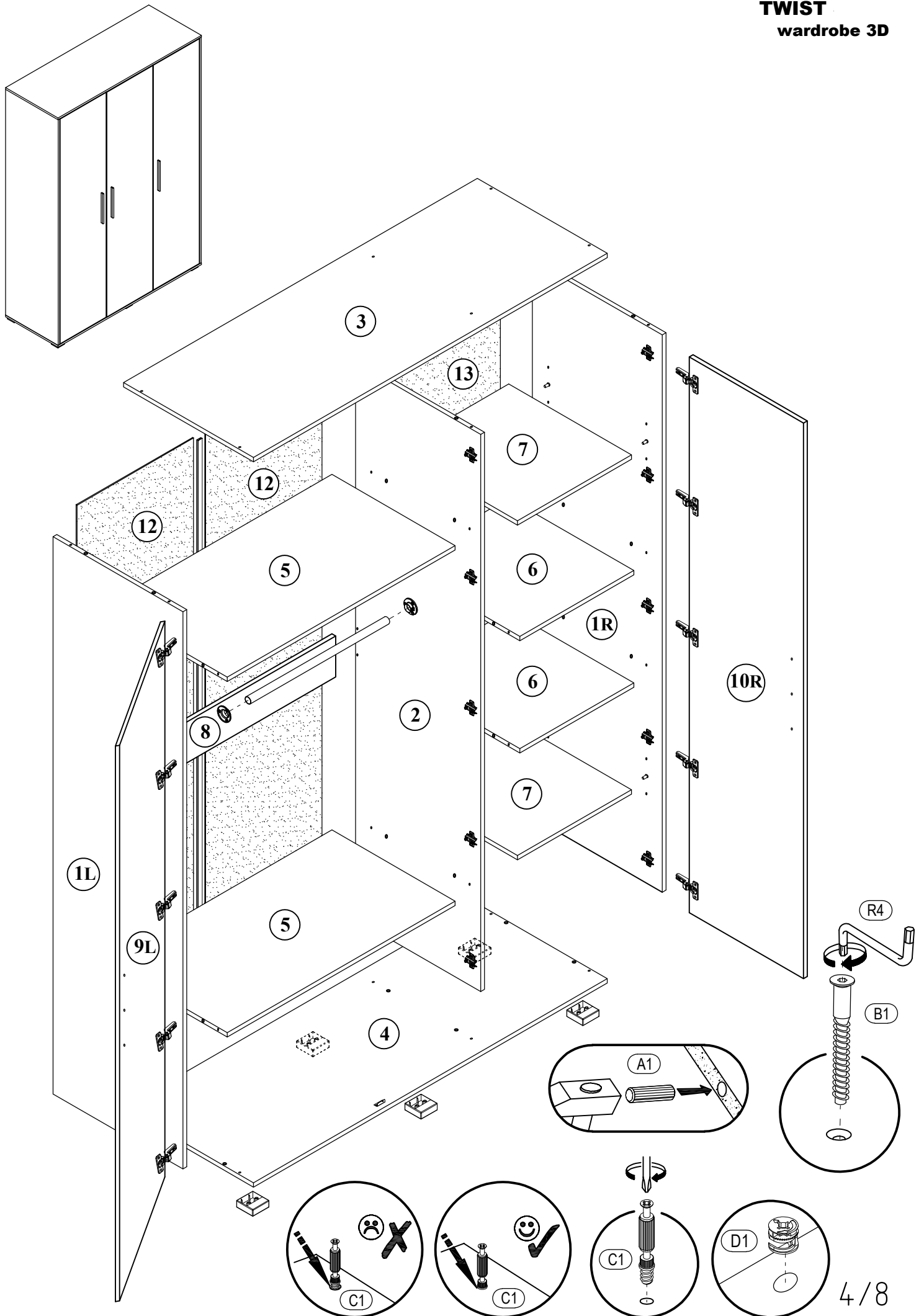

TWIST wardrobe 3D

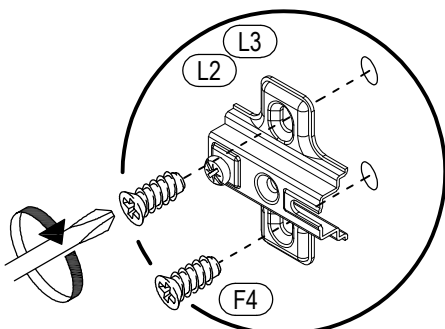
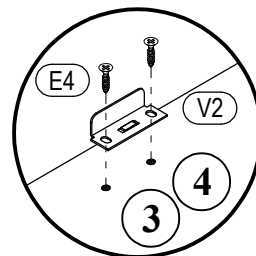
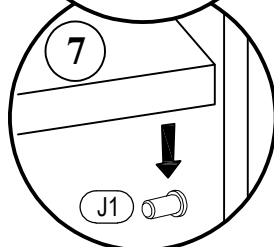
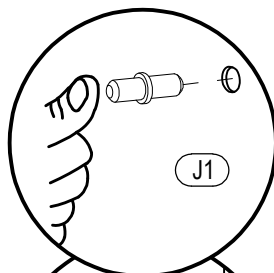
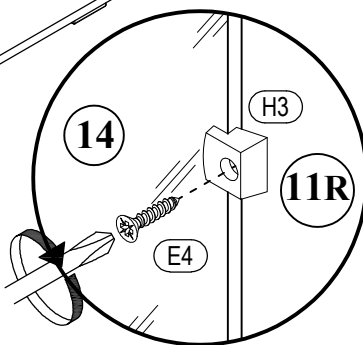
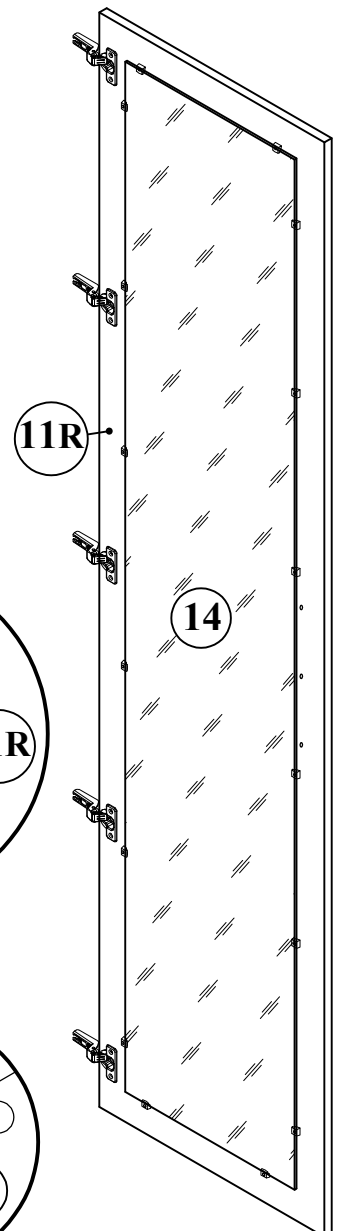
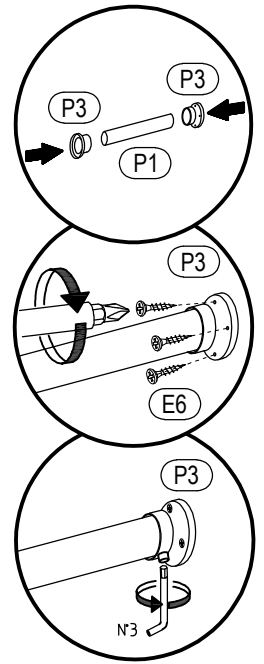
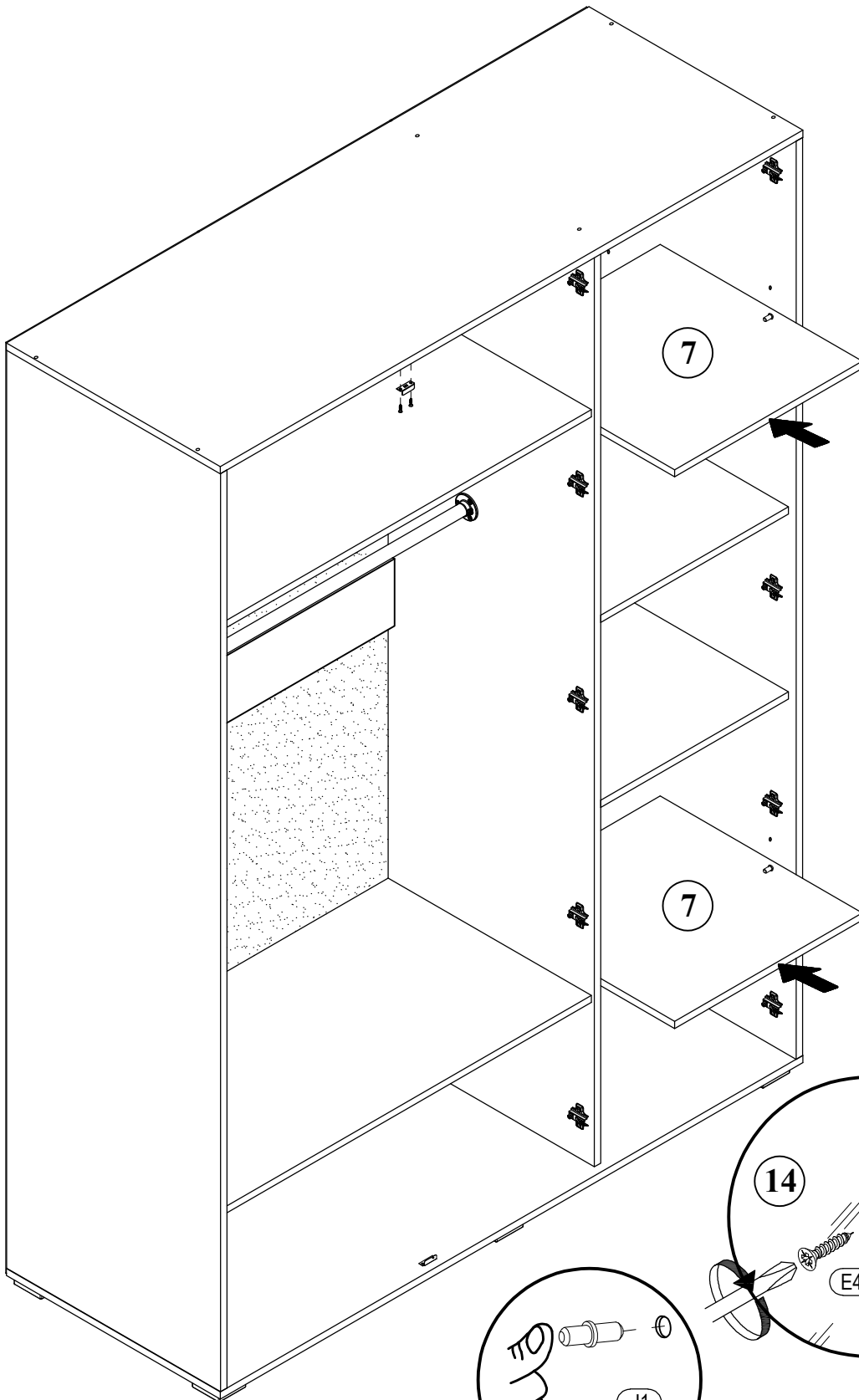

TWIST wardrobe 3D

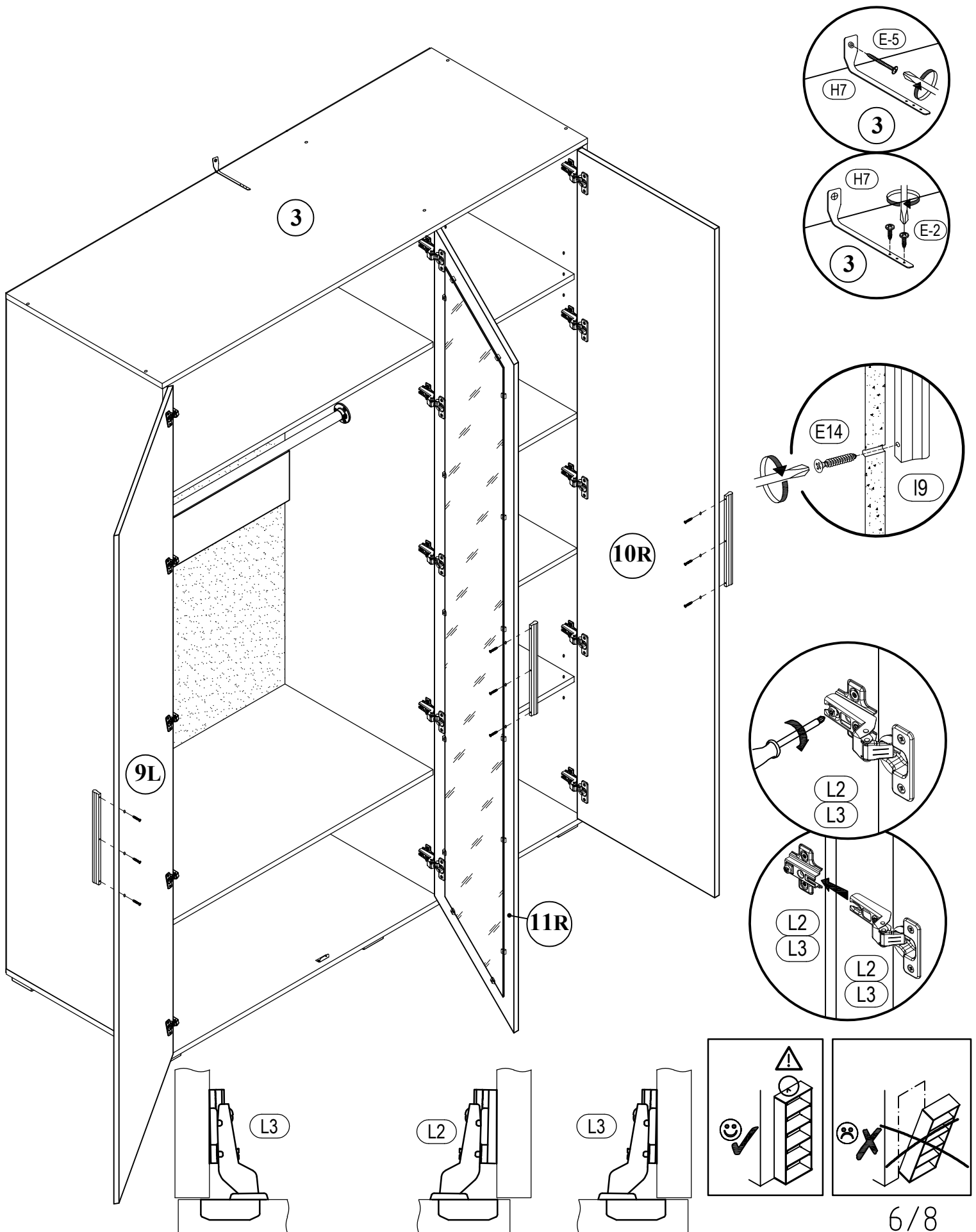

TWIST

wardrobe 3D

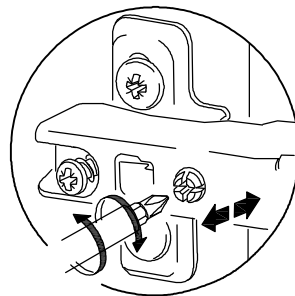
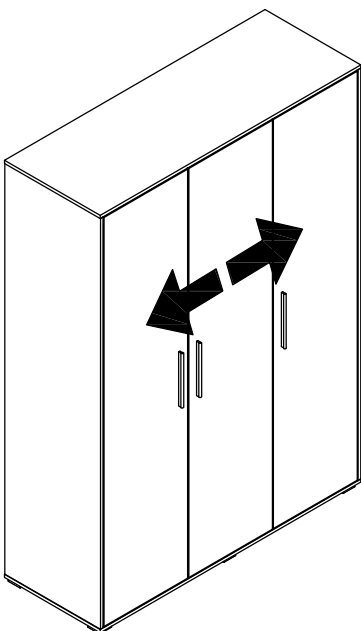
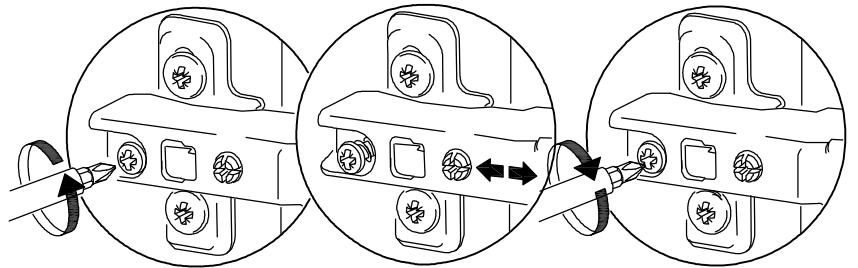
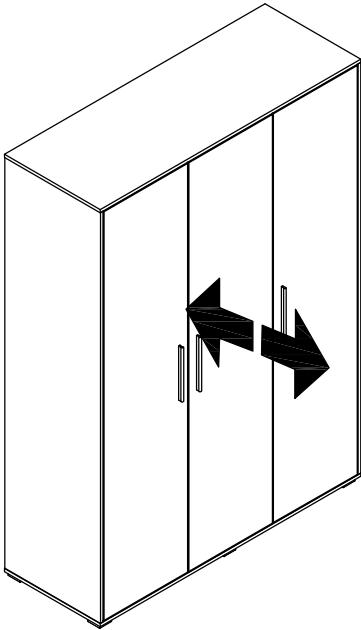
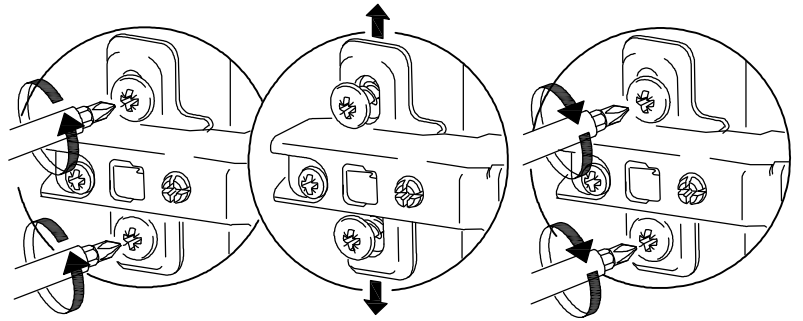
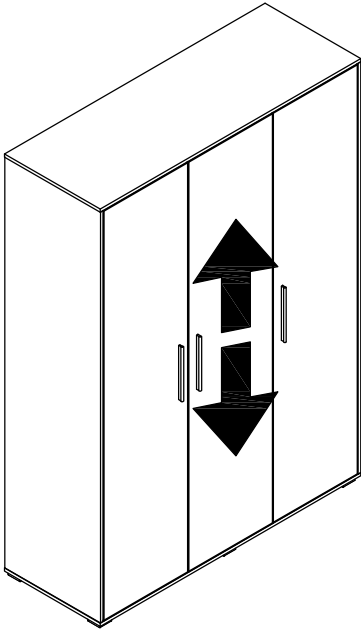

TWIST wardrobe 3D

