

TWIST

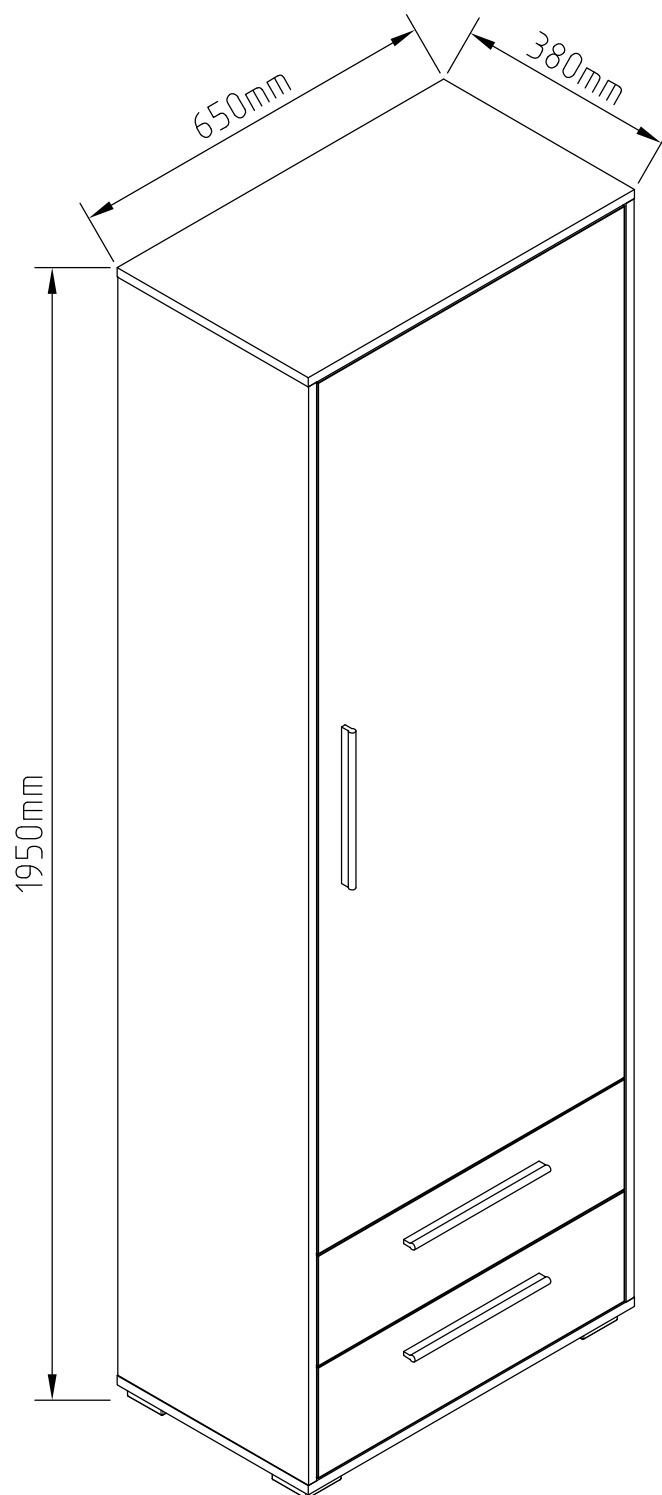







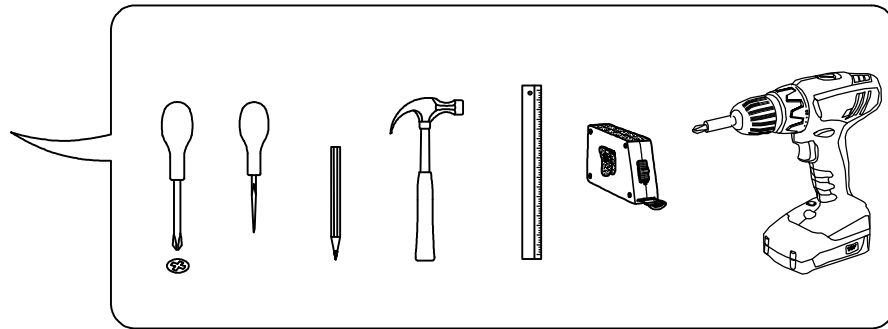
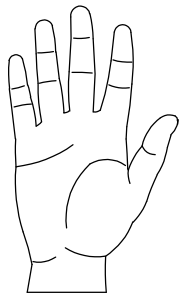

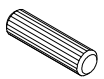

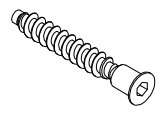
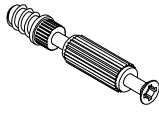



CABINET 1D2Dr

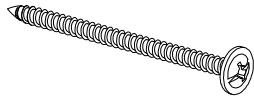

TWIST

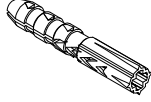
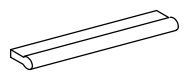
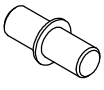
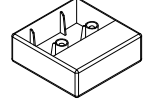
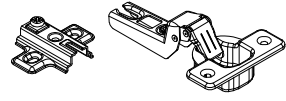
cabinet 1D2Dr

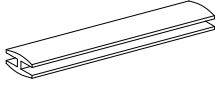
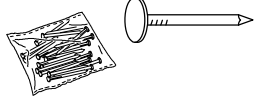
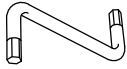
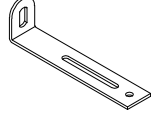

 A1 8*30mm x28	 B x8	 B1 6,3*50mm x8
 C1 6*43mm x12	 D ϕ 20mm x12	 D1 15/16 x12
 E4 3*15mm x2	 E6 3,5*16 x24	 E14 4*25mm x9
 E16 4*35mm x8	 E-2 4,2*16mm x2	 E-5 4,2*65mm x1
 F4 6,3*13mm x8	 H5 8*50mm x1	 I9 x3
 J1 5*16mm x12	 K4 x4	 L3 x4
 M2 L-350mm x2	 O8 L-1890 mm x1	 R3 1.4*25mm 0.060kg
 R4 N°4 x1	 S16 260.54.900 x1	 U3 x2

TWIST

cabinet 1D2Dr

  x1		

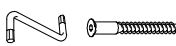
№	a*b	x	№→...
1L	1894x380	x1	1/3
1R	1894x380	x1	1/3
2	650x380	x1	2/3
3	650x380	x1	2/3
4	616x360	x1	2/3
5	615x350	x3	1/3
6	1502x610	x1	3/3
7	610x190	x1	3/3
8	610x190	x1	3/3
9L	350x120	x2	2/3
9R	350x120	x2	2/3
10	558x120	x2	2/3
11	587x353	x2	2/3
12	1922x322	x1	1/3
13	1922x322	x1	1/3
		x1	2/3

TWIST cabinet 1D2Dr

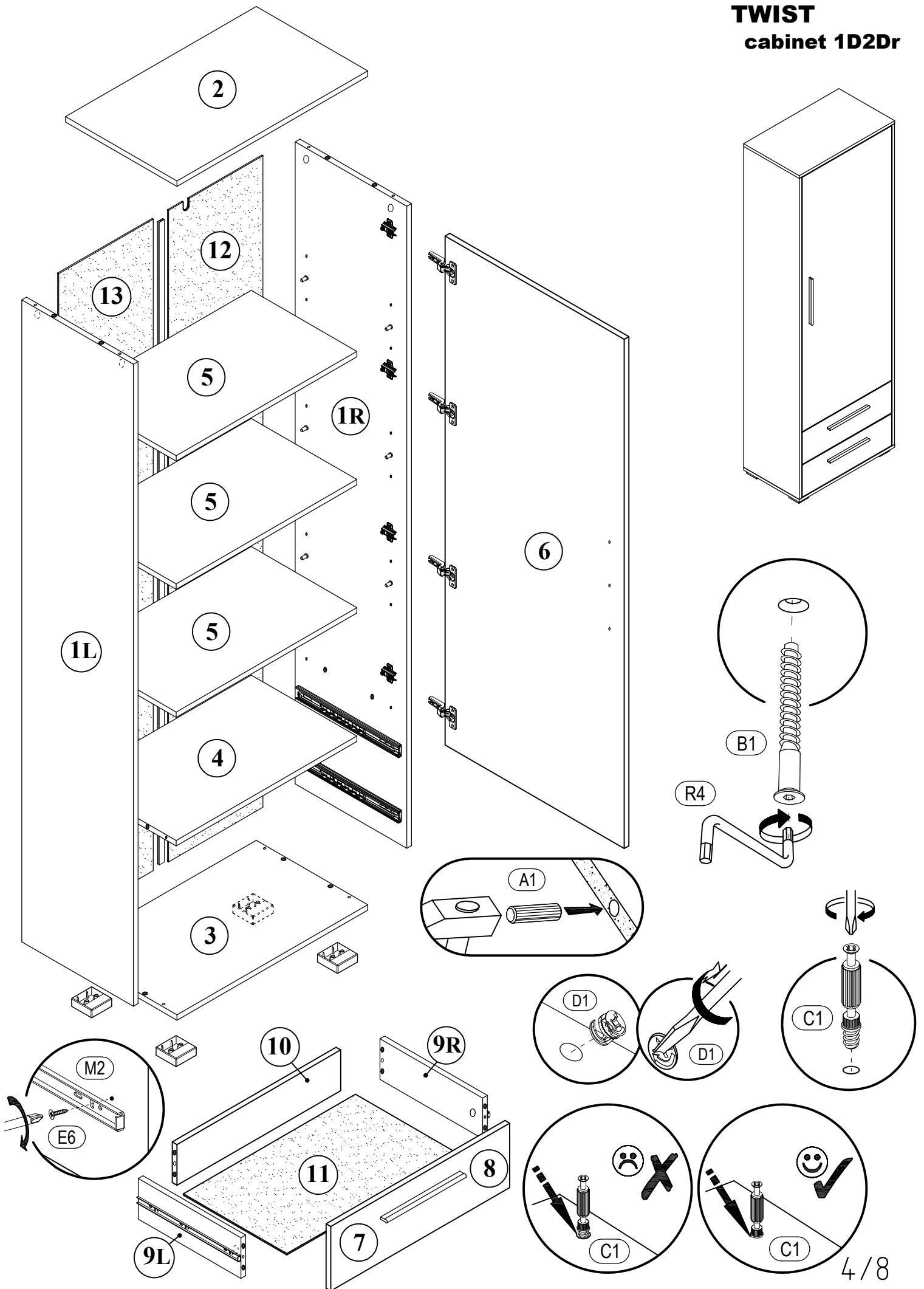

TWIST

cabinet 1D2Dr

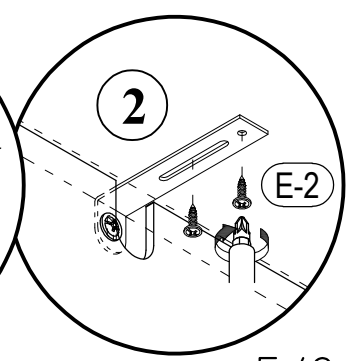
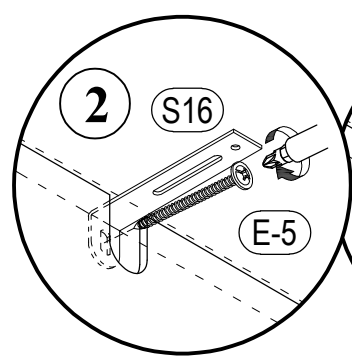
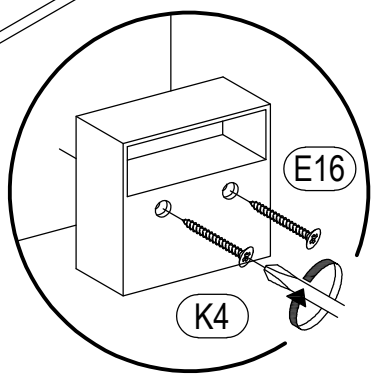
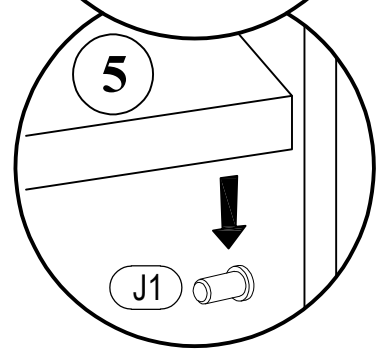
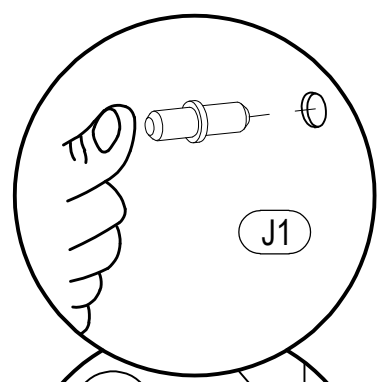
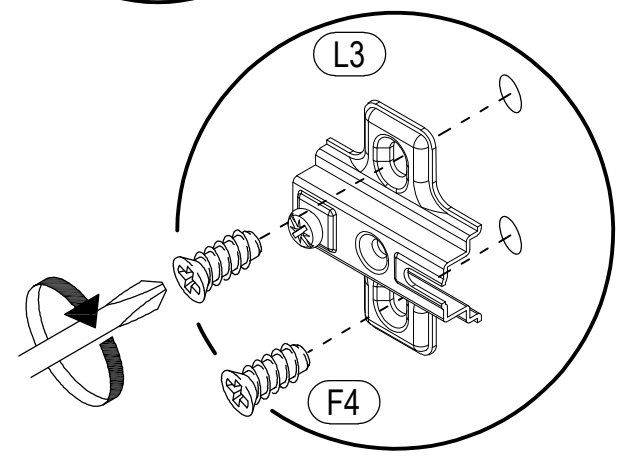
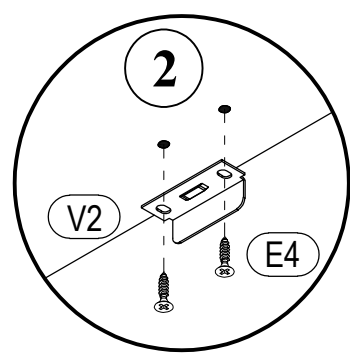
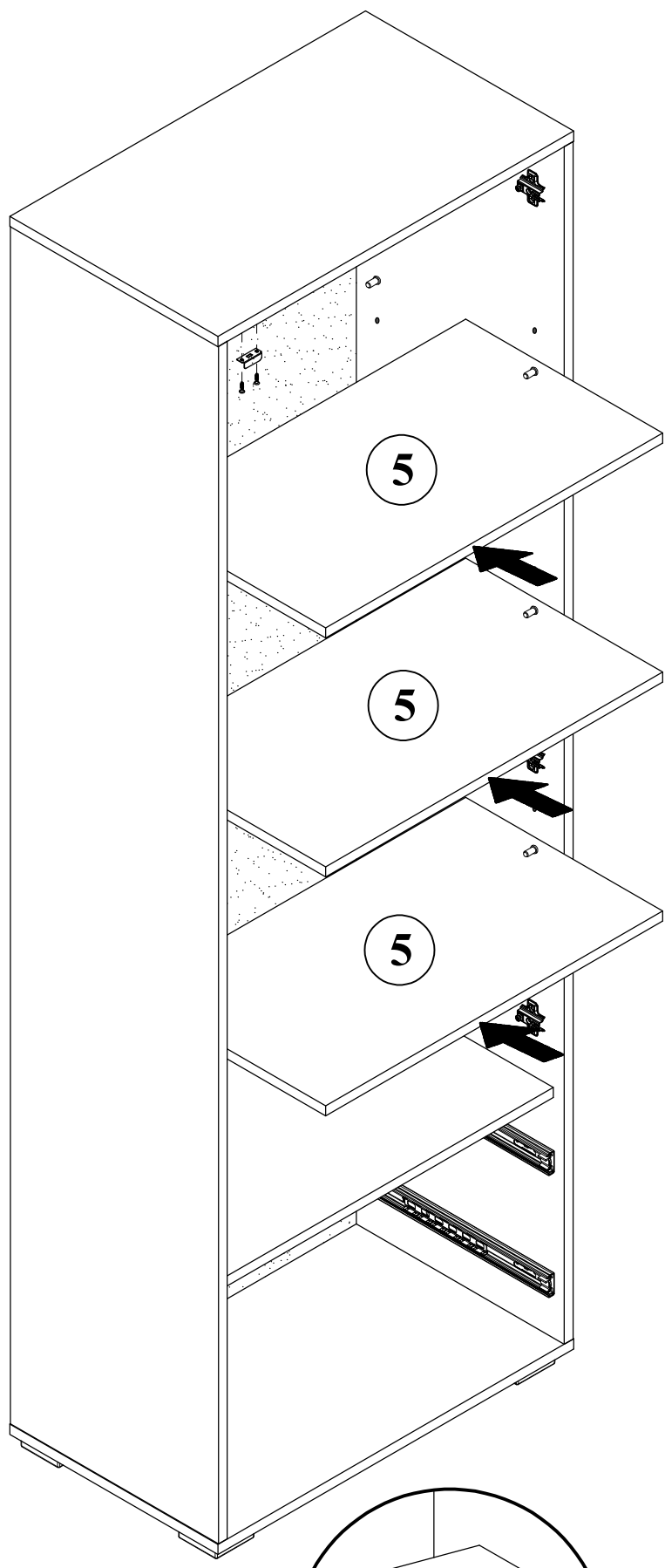

TWIST cabinet 1D2Dr

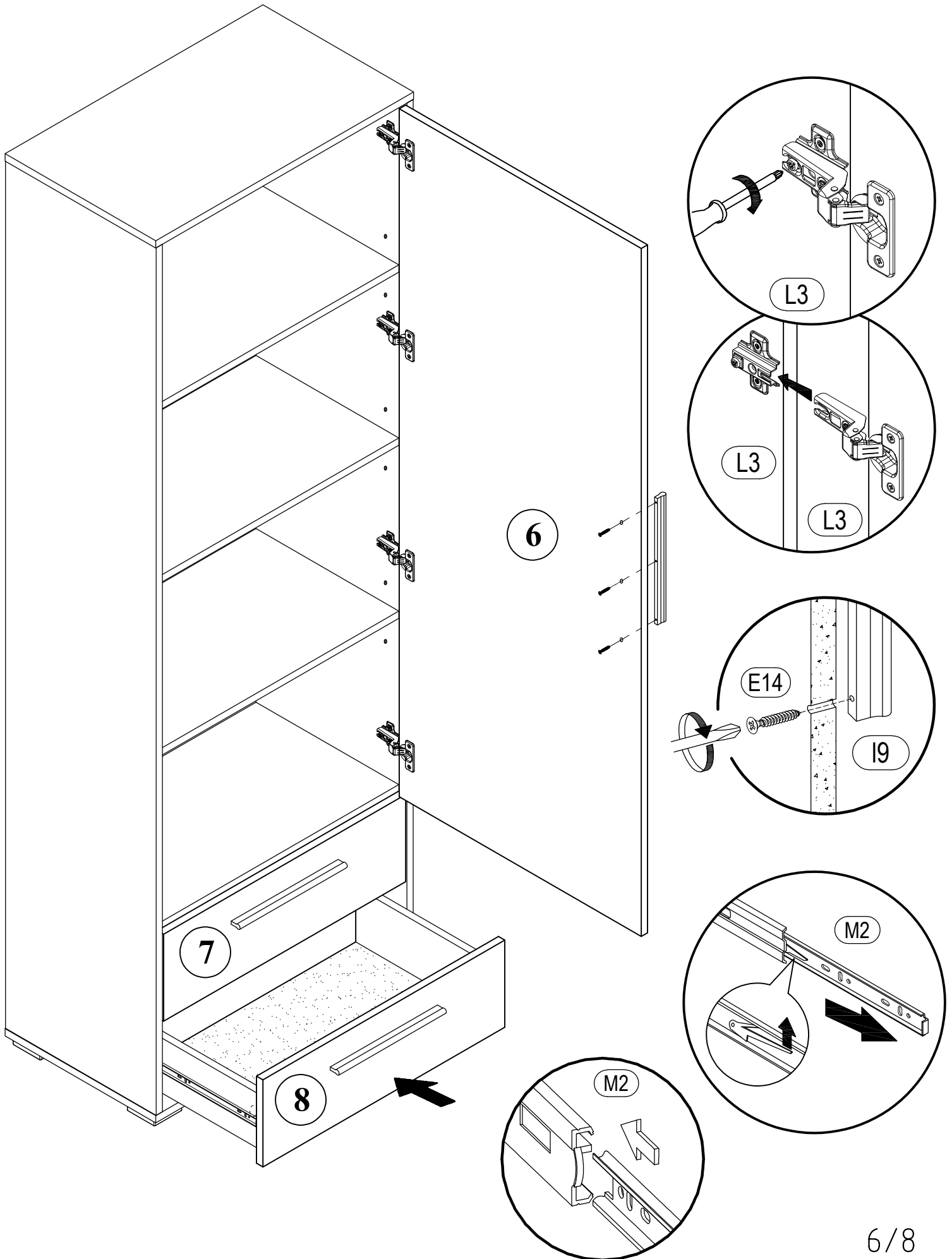

TWIST

cabinet 1D2Dr

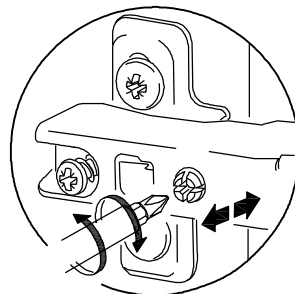
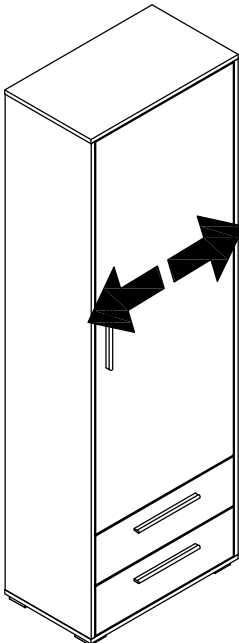
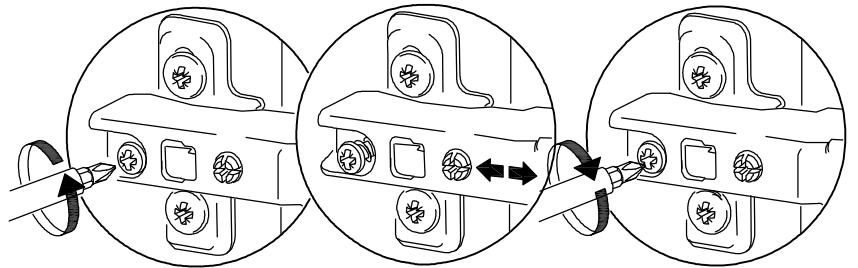
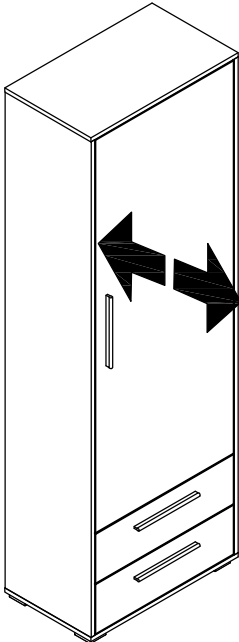
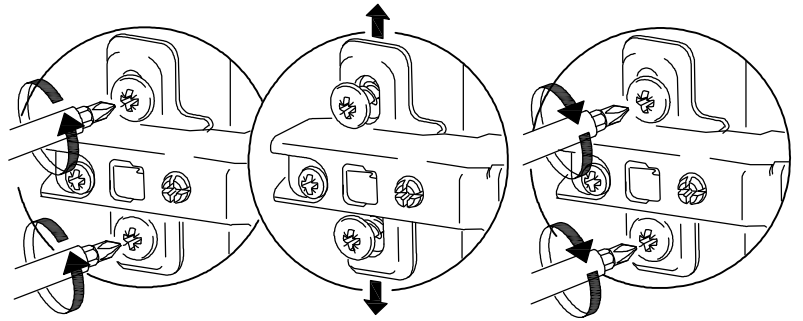
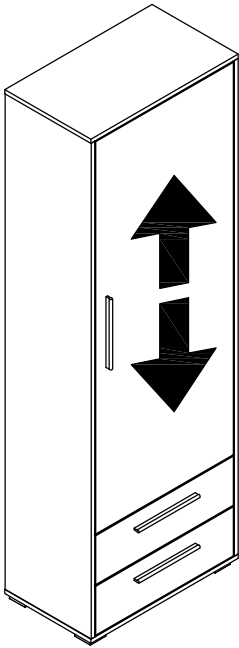

TWIST cabinet 1D2Dr

