

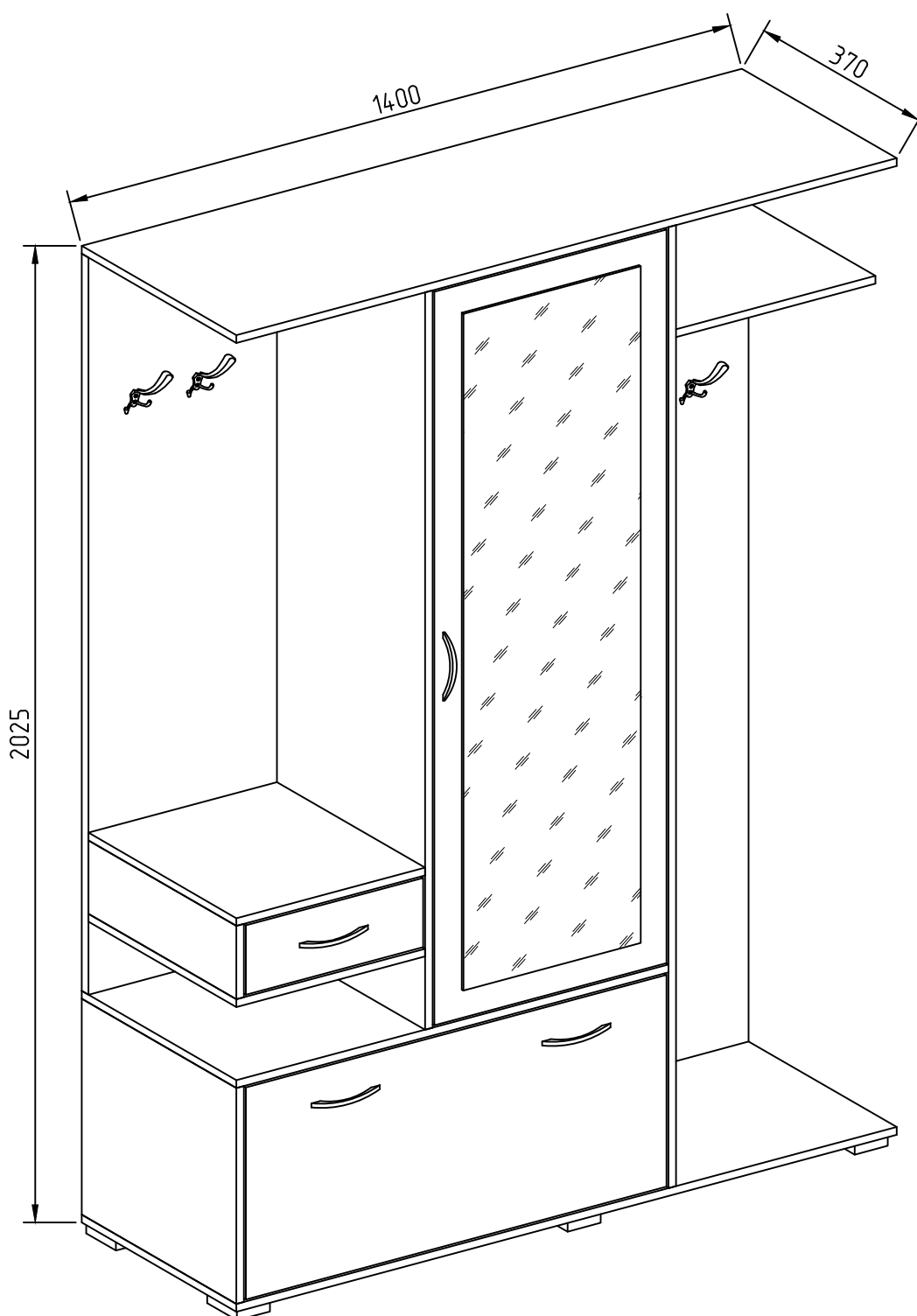

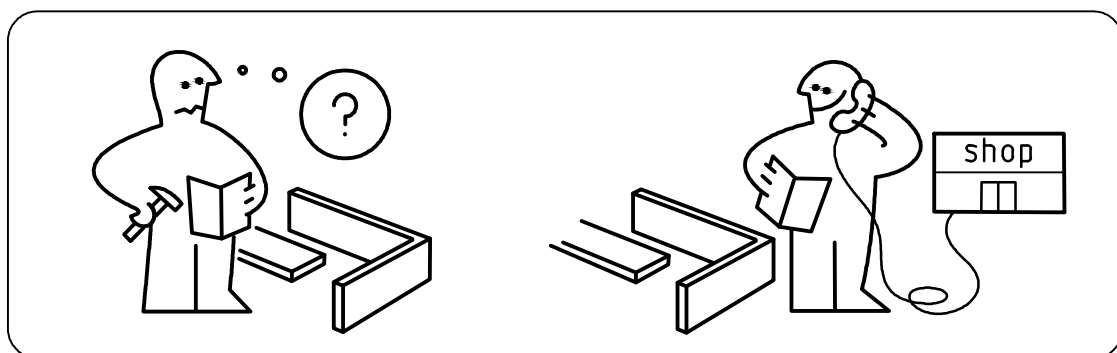

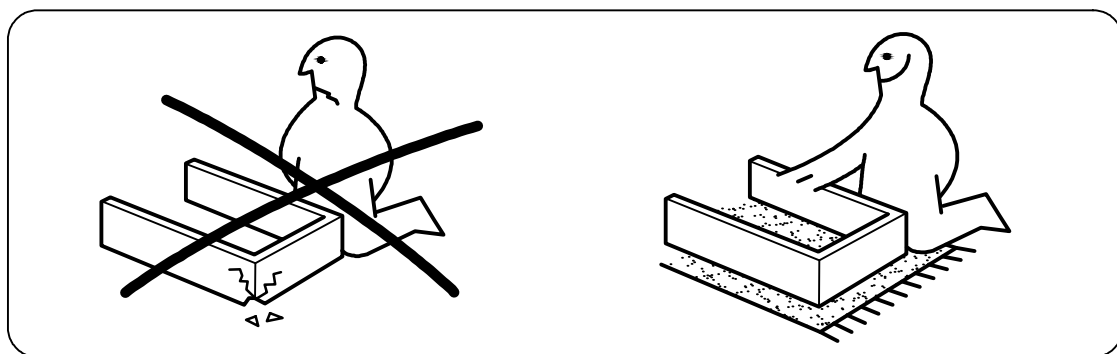

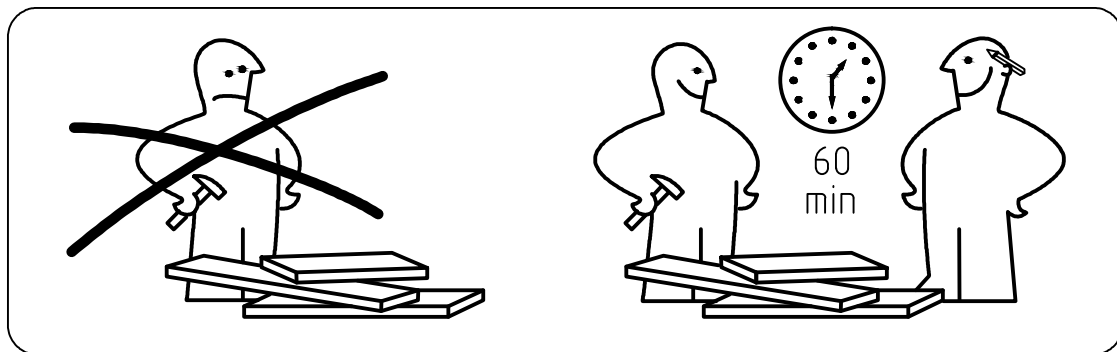

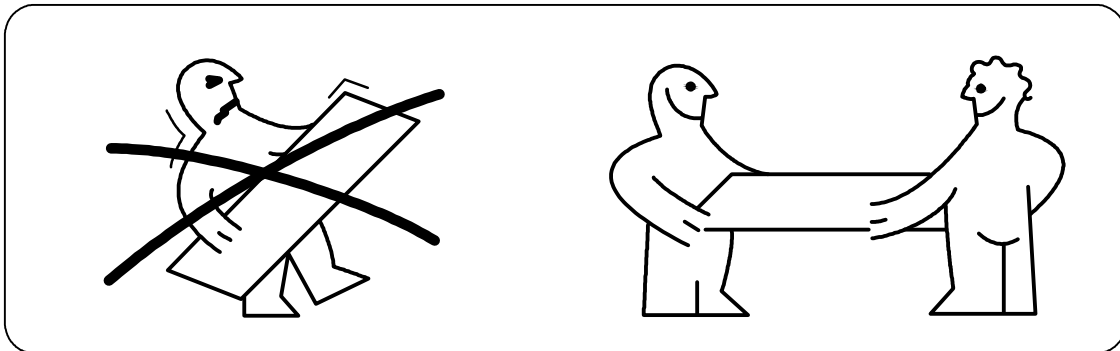
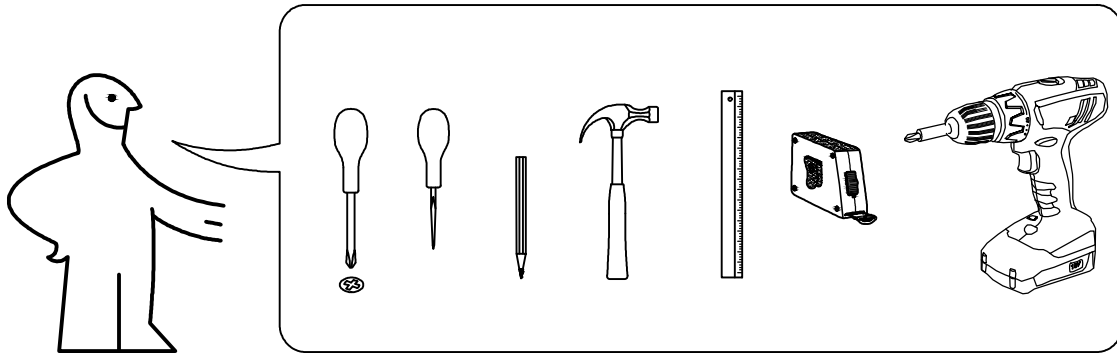

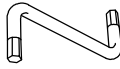



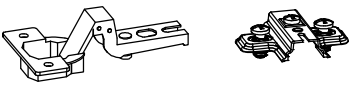

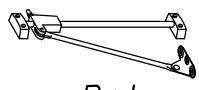

GRETA

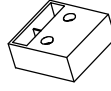

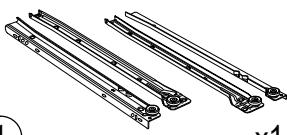

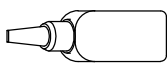
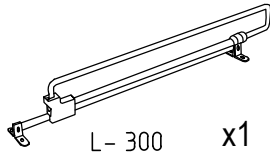
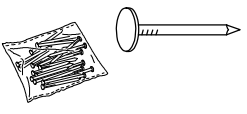
 B1 6,3*50mm x43	 B x20	 R4 Nº4 x1
 C1 5*30mm x2	 D1 16mm x2	 D x2
 L3 x6	 F5 6,3*13mm x12	 E9 4*16mm x18
 J1 5*16mm x5	 N4 R + L x1	 E4 3*20mm x8
 E3 3*15mm x6	 K4 311.09.K02 x6	 E10 4*30mm x12
 M1 L- 300mm x1	 A1 8*30mm x15	 E2 3*13mm x8
 R1 x1	 N6 L- 300 x1	 R3 1.4*25mm 0.050kg
 X3 DW59 x4	 I18 x4	

	a*b	x
1 R	1968x366	1
1 L	1510x366	1
2	442x366	1
3	442x348	1
4	150x350	1
5	916x366	1
6	400x350	1
7	1400x366	1
8	1400x366	1
9	400x350	1
10	421x345	1
11	468x300	1
12	1510x400	1
13	1968x468	1
14	434x892	1
15	1502x492	1
16	142x376	1
17	300x100	2
18	328x100	1
19	303x356	1
20	1530x528	1
21	928x465	1
22	1385x375	1

