

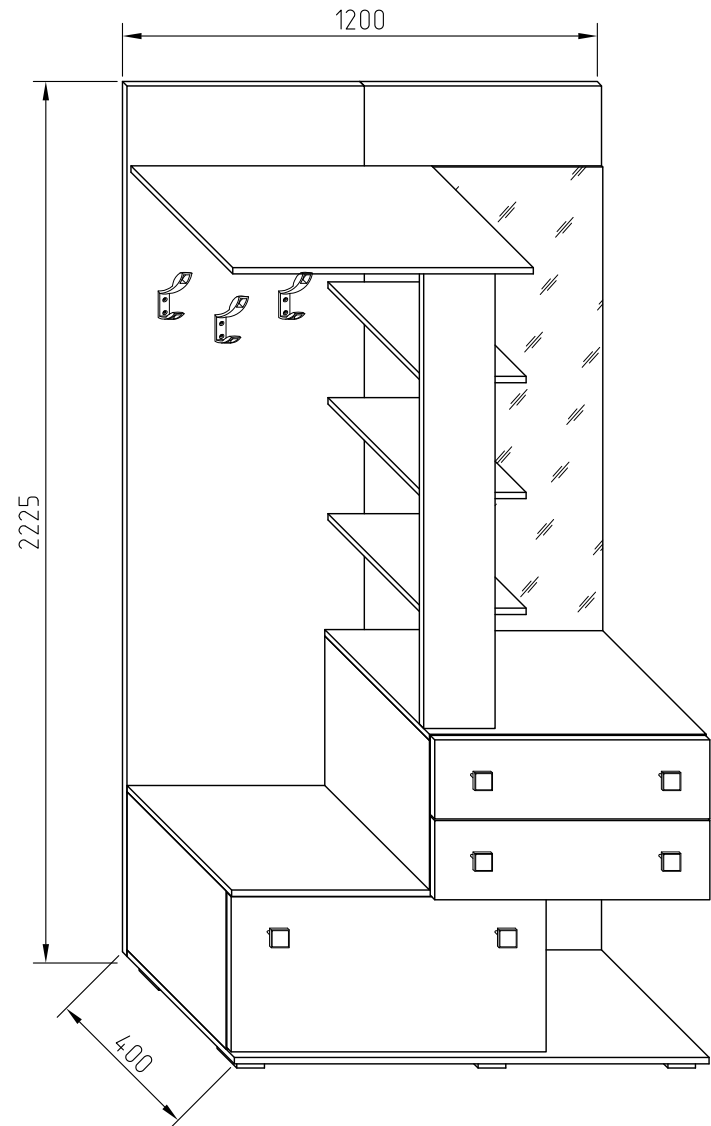

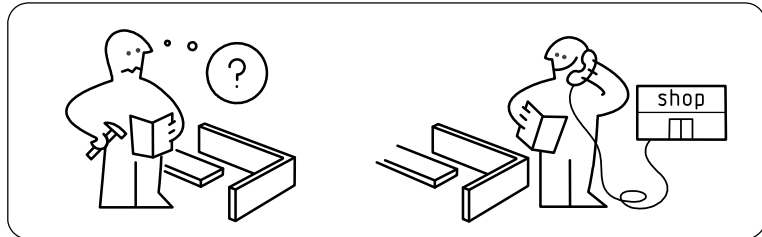

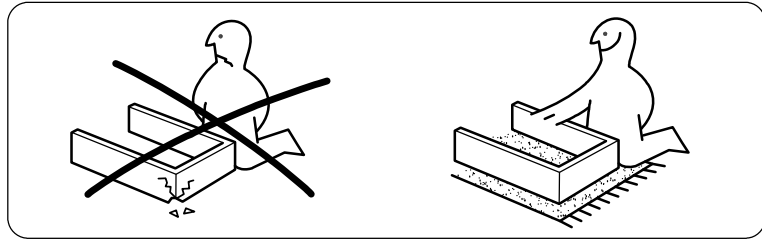

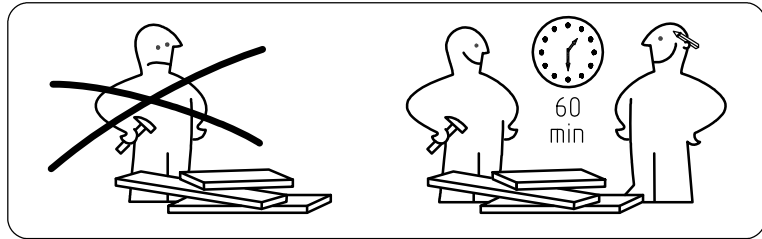

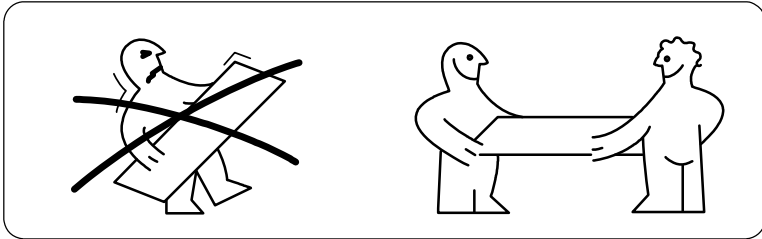
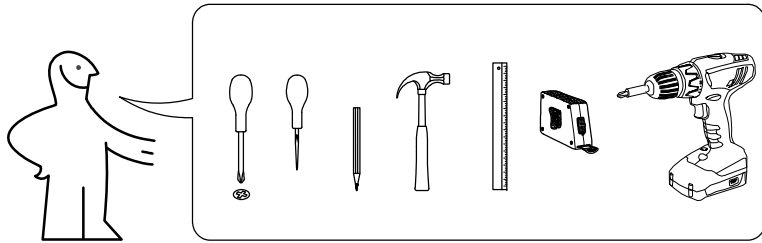
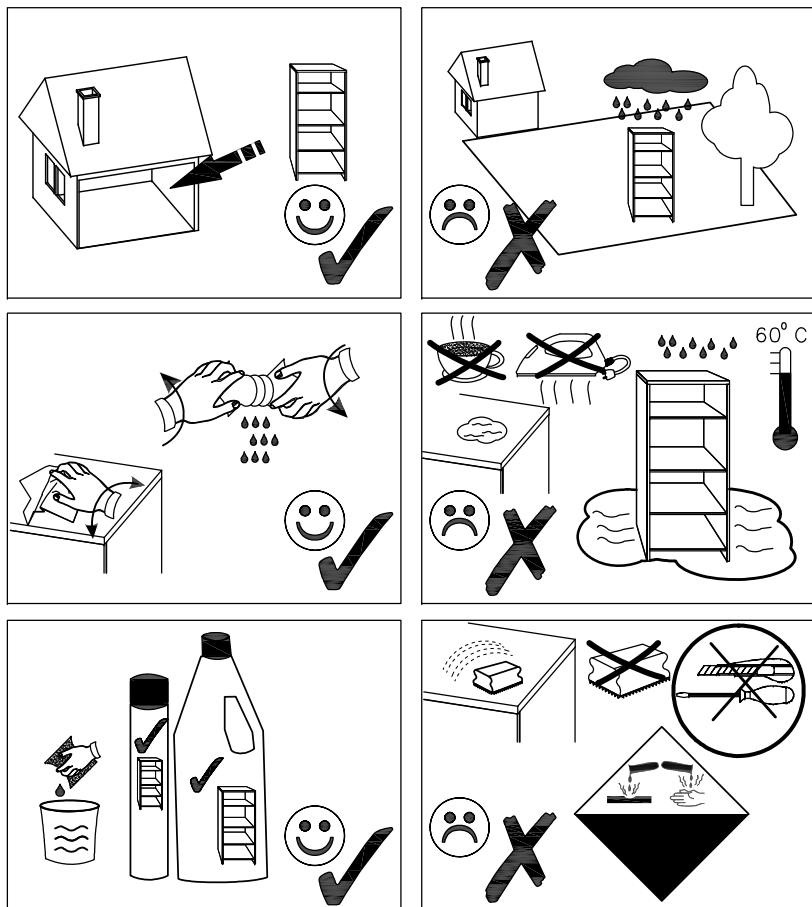
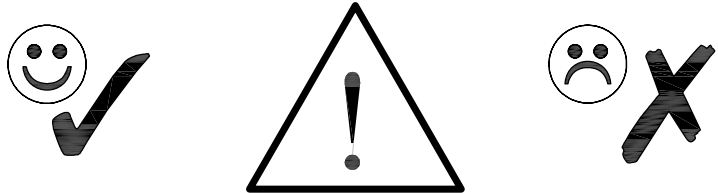















SONATA



Sonata

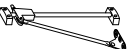

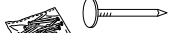

 A1 8*30mm x32	 B x20	 B1 6,3*50mm x39
 C1 5*30mm x4	 D1 16mm x4	 D x4
 E2 3*13mm x16	 E3 3*15mm x6	 E4 3*20mm x8
 E8 4*16mm x4	 E11 4*35mm x12	 F1 6,3*13mm x4
 G6 M 4*25mm x12	 H1 M 4 x12	 I24 x6
 J1 5*16mm x4	 K4 311.09.K02 x6	 L3 x2
 M1 L- 350mm x2	 N4 R+L x2	 R1 x1
 R3 14*25mm 0.050kg	 R4 N°4 x1	 X4 DW08 x3

15

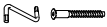
№	a*b	x	№→...
1L	400x354	x1	4
1R	400x354	x1	4
2L	378x374	x1	3
2R	378x374	x1	3
3	400x354	x1	3
4	1200x374	x1	2
5	700x374	x1	4
6	760x364	x1	4
7	1200x384	x1	2
8	262x338	x3	4
9	374x350	x1	3
10	2200x600	x1	1
11	2200x600	x1	1
12	1156x180	x1	2
13	796x392	x1	3
14	696x200	x2	2
15L	350x120	x2	2
15R	350x120	x2	2
16	612x120	x2	2
17	353x640	x2	3
18	1170x428	x1	
		x1	2

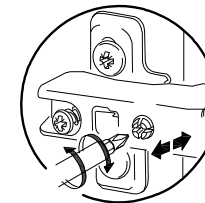
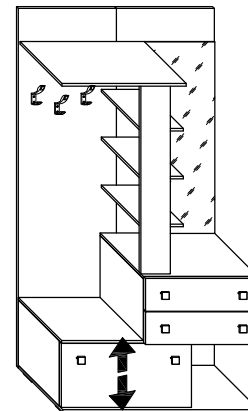
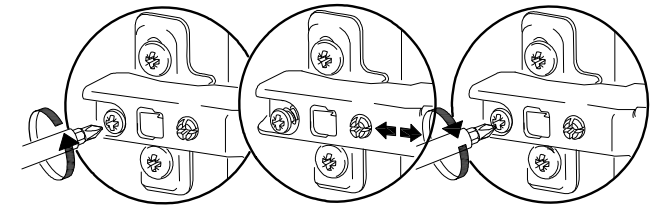
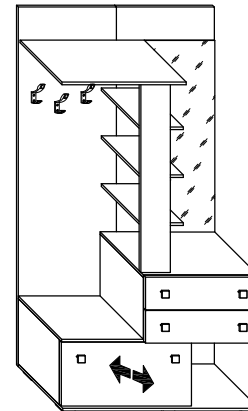
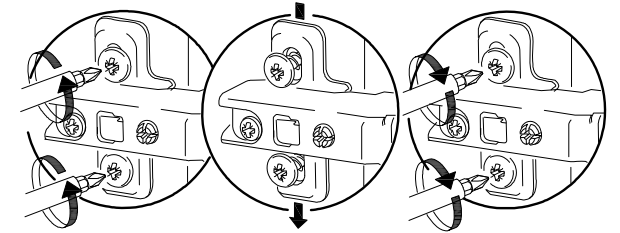
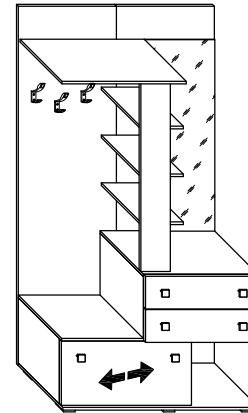



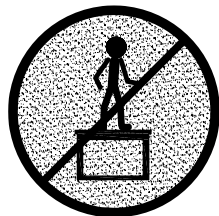
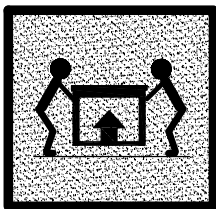
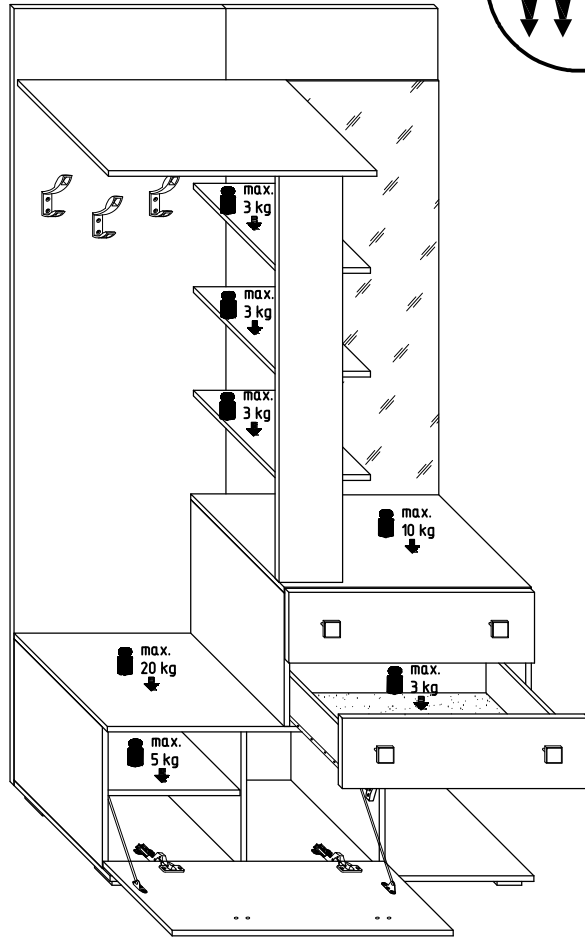
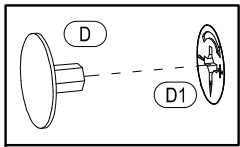
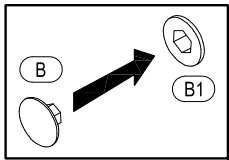
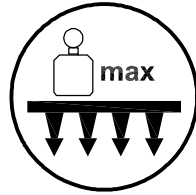
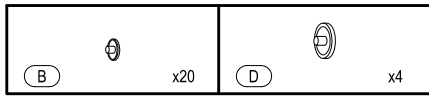

Sonata

14

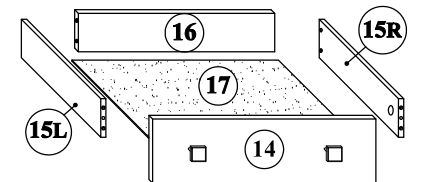
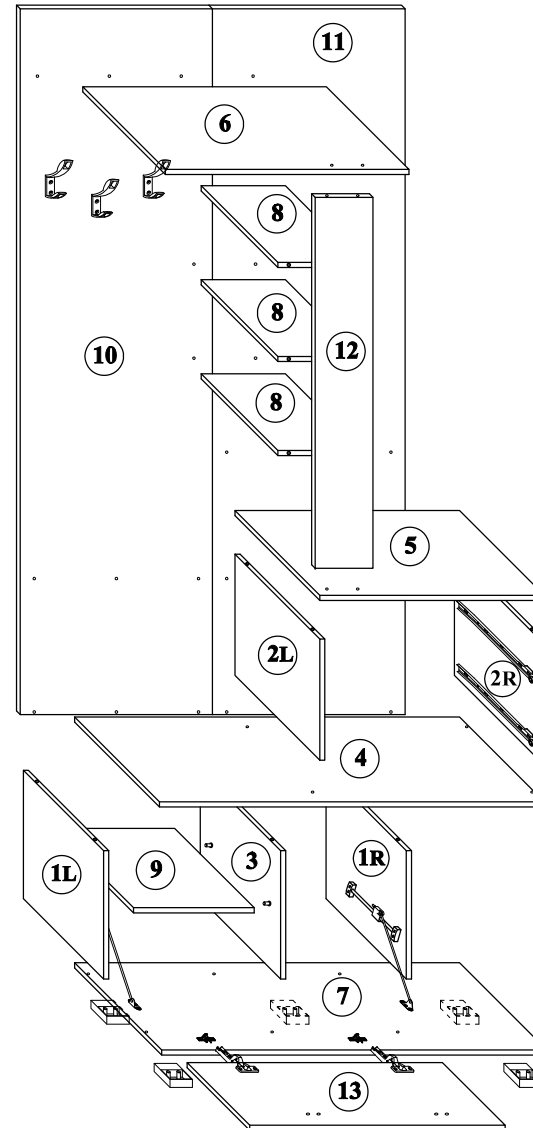
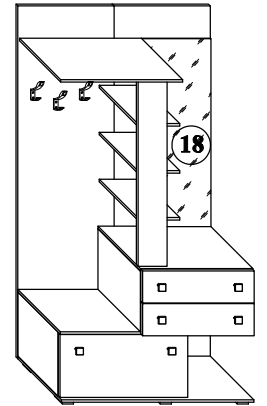

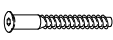

Sonata

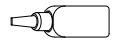

 <p>A1 8*30mm x6</p>	 <p>B1 6.3*50mm x6</p>	 <p>R4 N°4</p>
 <p>R1</p>		

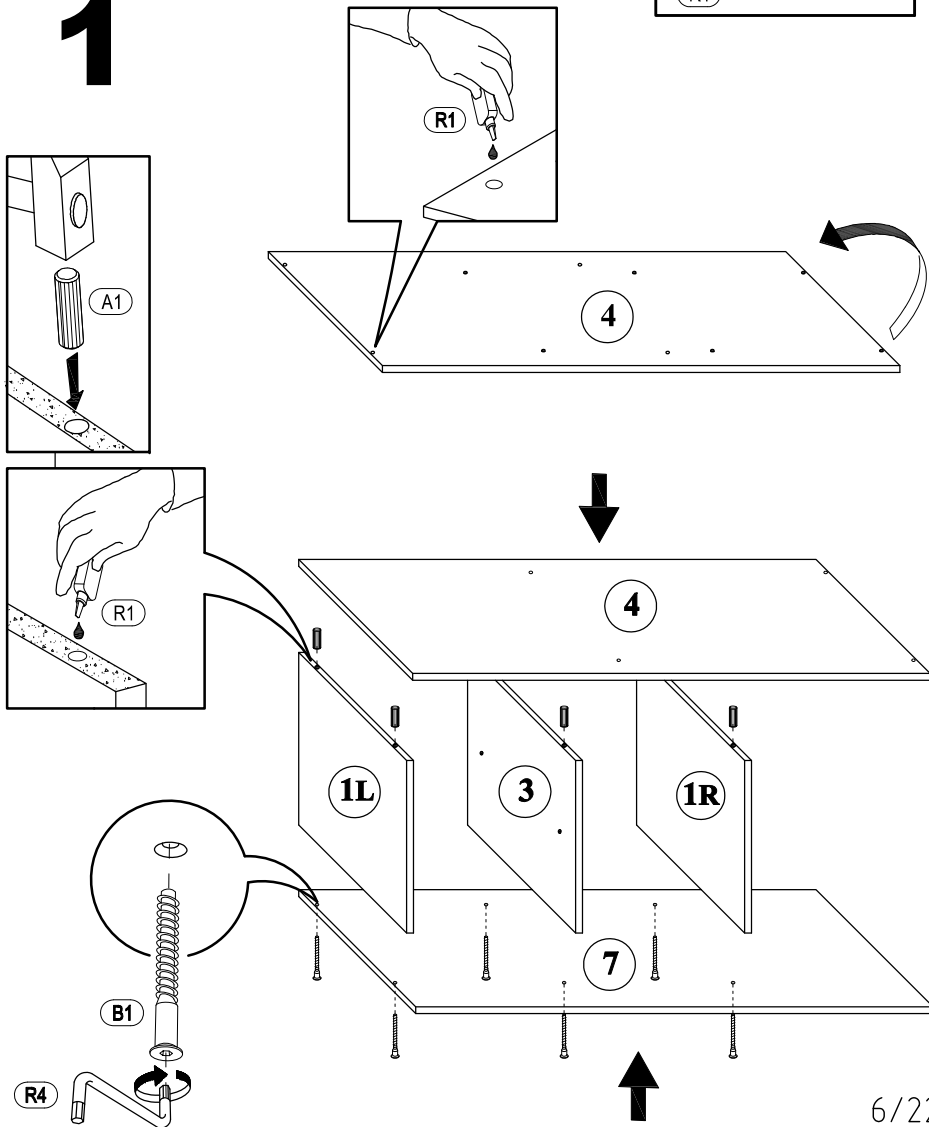
1



 <p>E3 3*15mm x6</p>	 <p>G6 M4*25mm x4</p>	 <p>H1 M4 x4</p>	 <p>I24 x2</p>
---	--	---	---

13

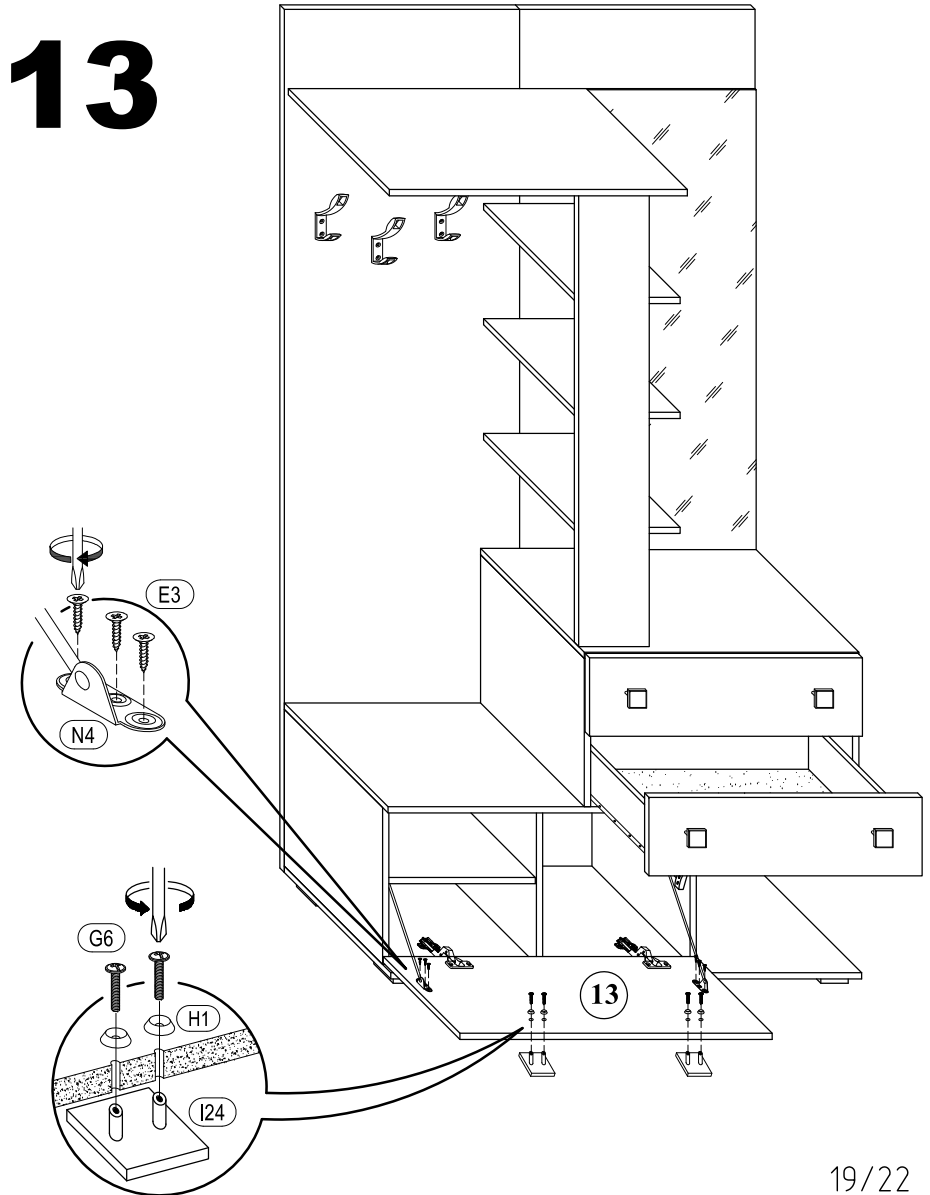

12

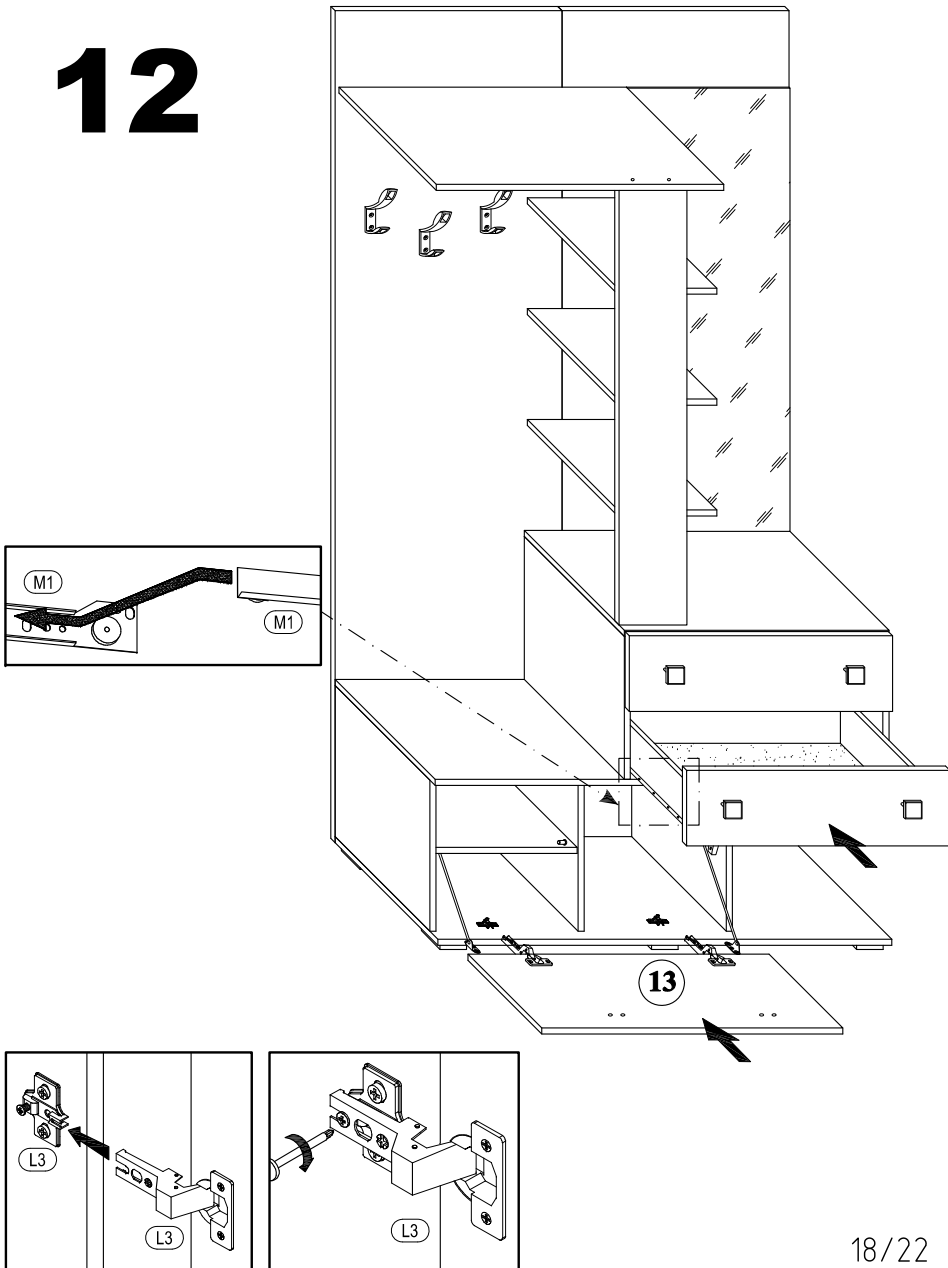

2

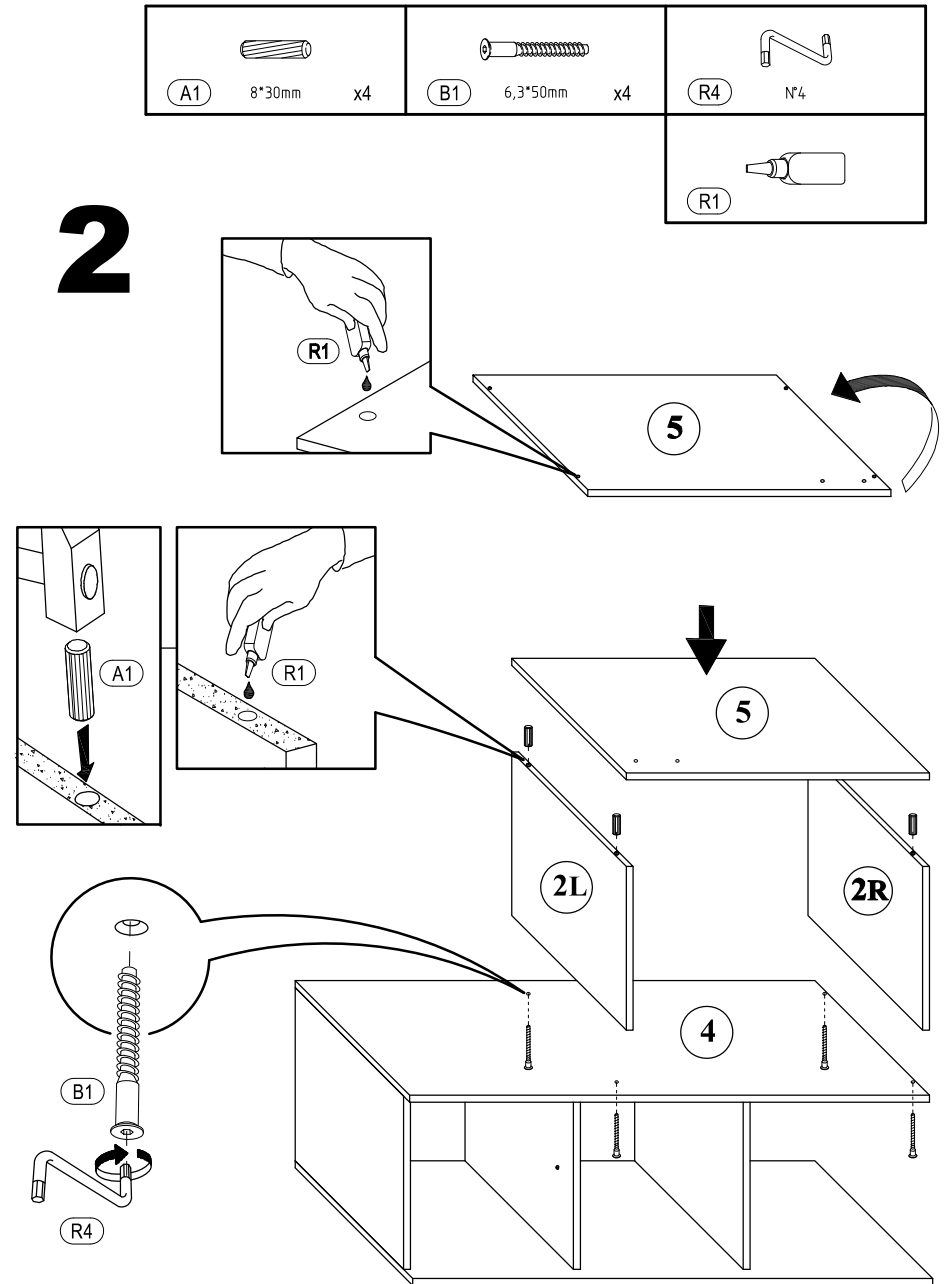

3

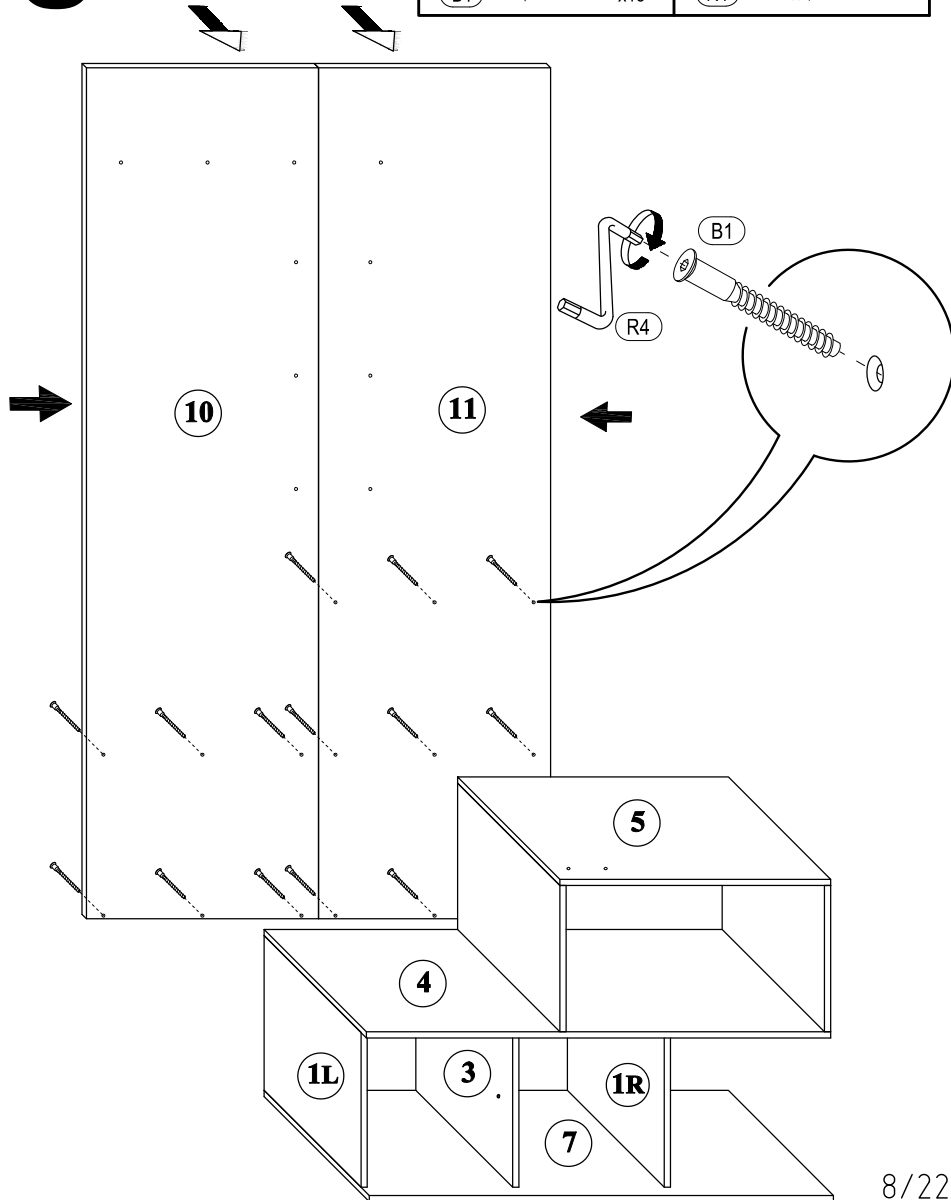



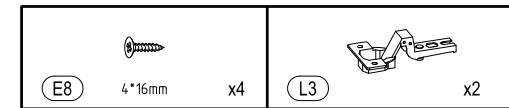
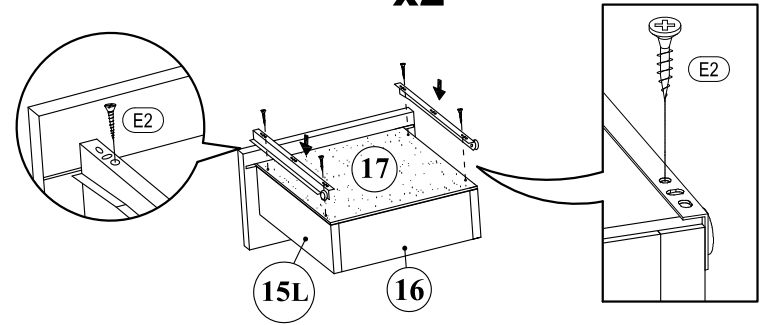

10

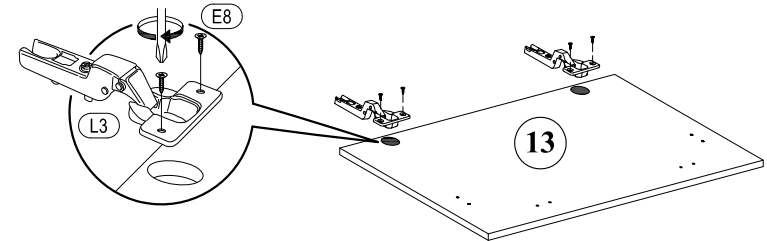

10.7
x2



11

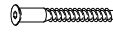

 <p>A1 8*30mm x8</p>	 <p>D1 16mm x4</p>	 <p>R3 1.4*25mm 0.050kg</p>
---	---	--

 <p>A1 8*30mm x4</p>	 <p>B1 6,3*50mm x6</p>	 <p>R4 N°4</p>
---	---	---

10

10.4
x2

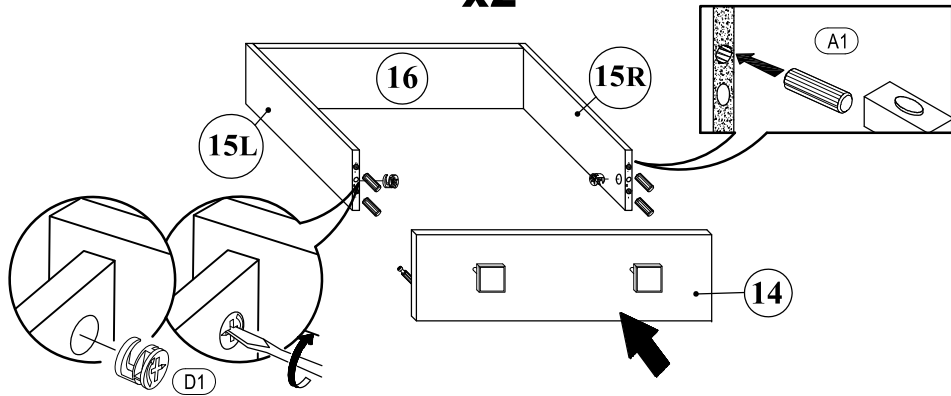

10.5
x2

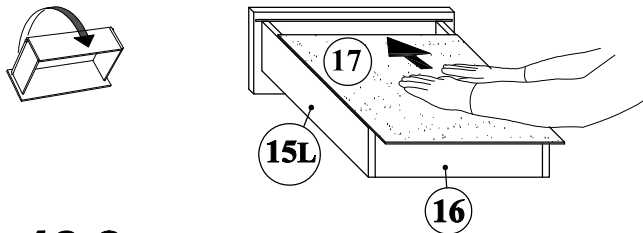

10.6
x2

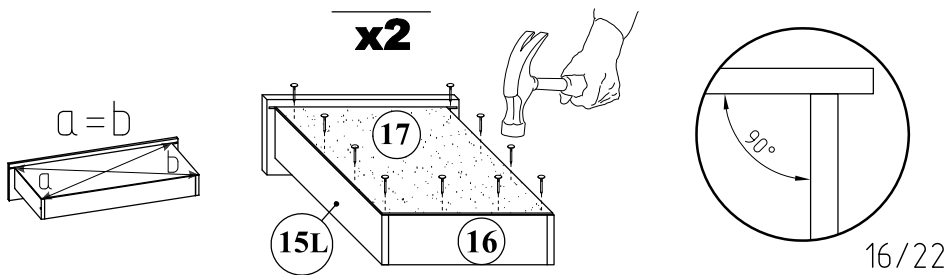



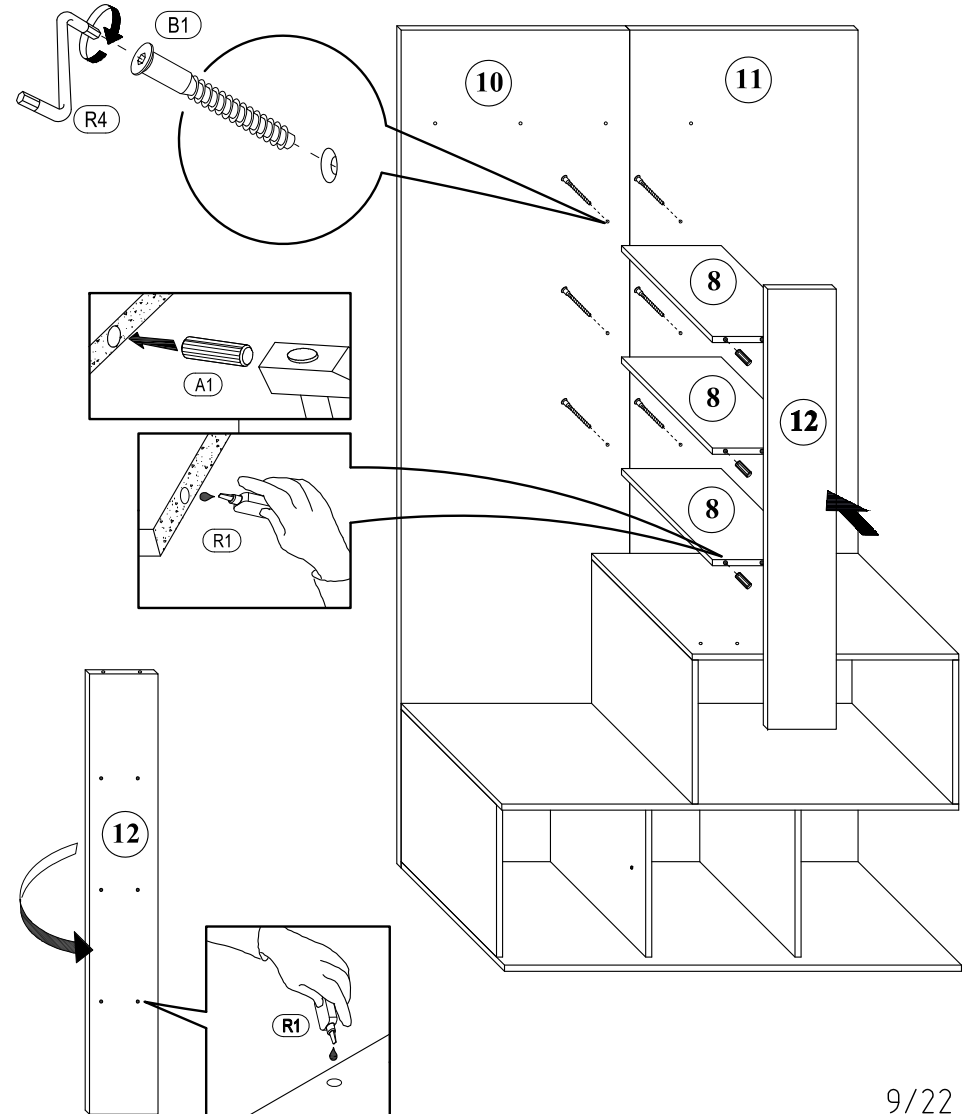

4

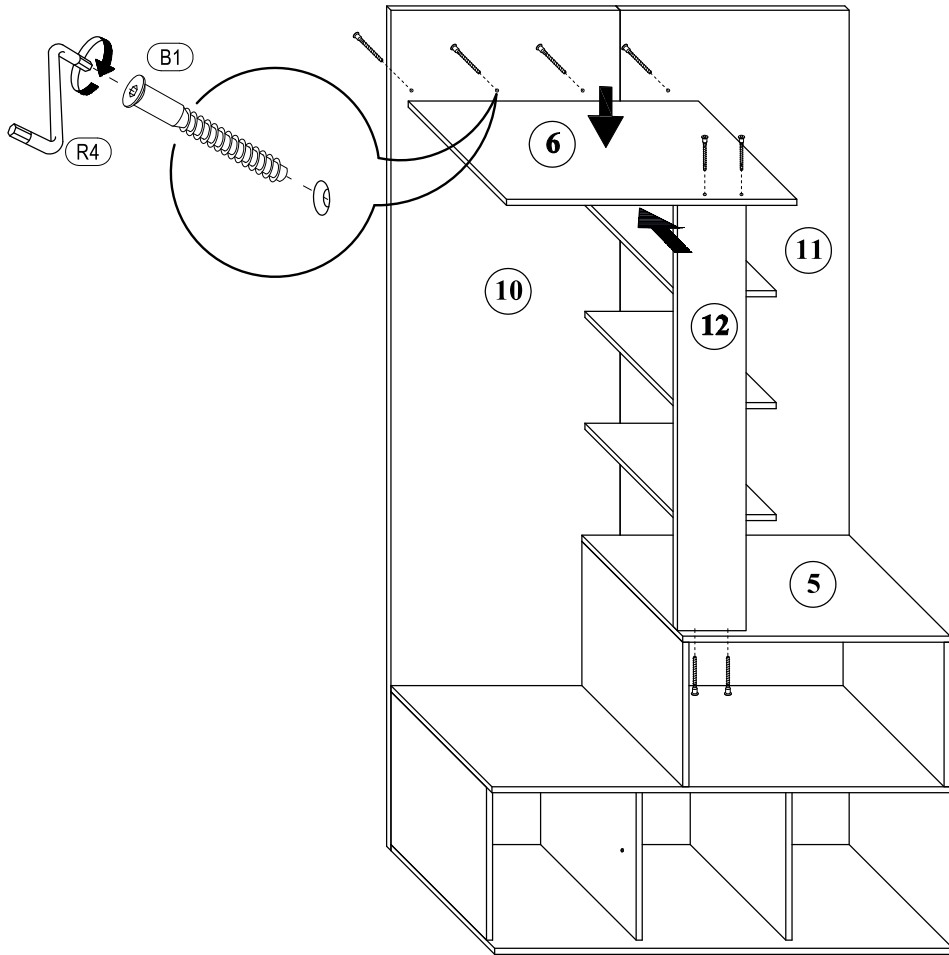

5



	
B1 6,3*50mm x8	R4 N°4



			
A1 8*30mm x8	C1 5*30mm x4	G6 M 4*25mm x8	H1 M 4 x8

10

10.1 x2

	
I24	x4

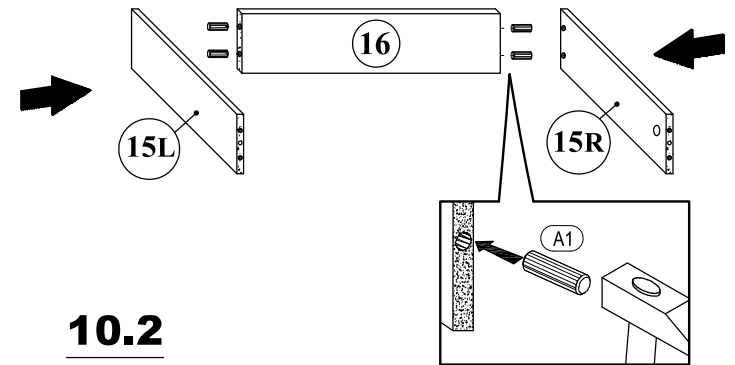

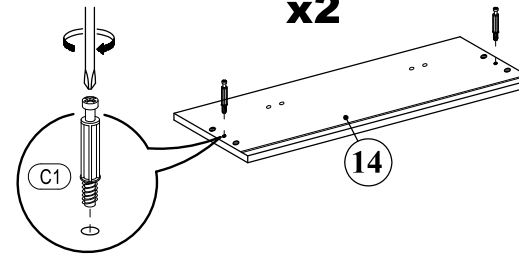

10.2 x2

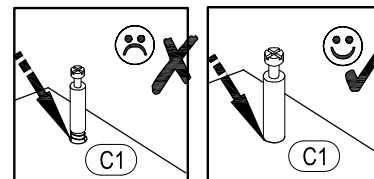
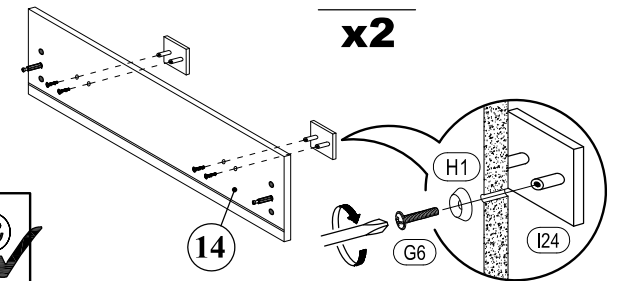

10.3 x2





9

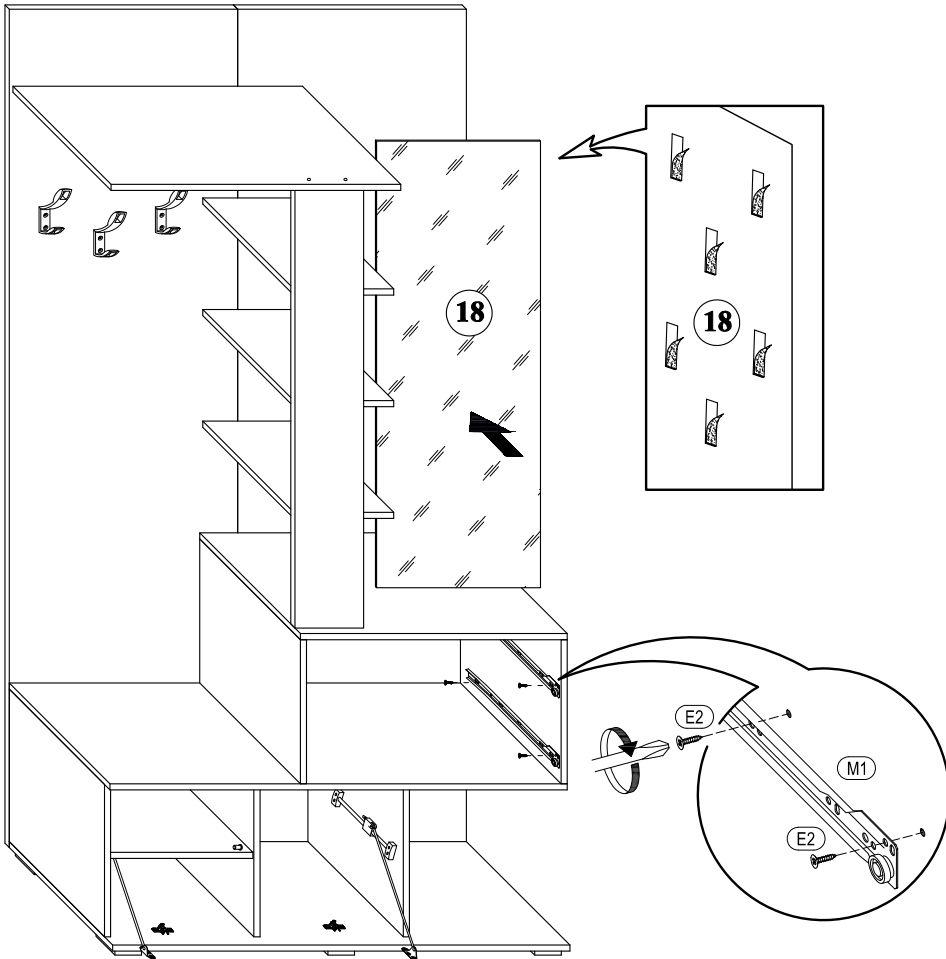

 <p>E2 3*13mm x8</p>	 <p>M1 R+L L- 350mm x2</p>
--	--

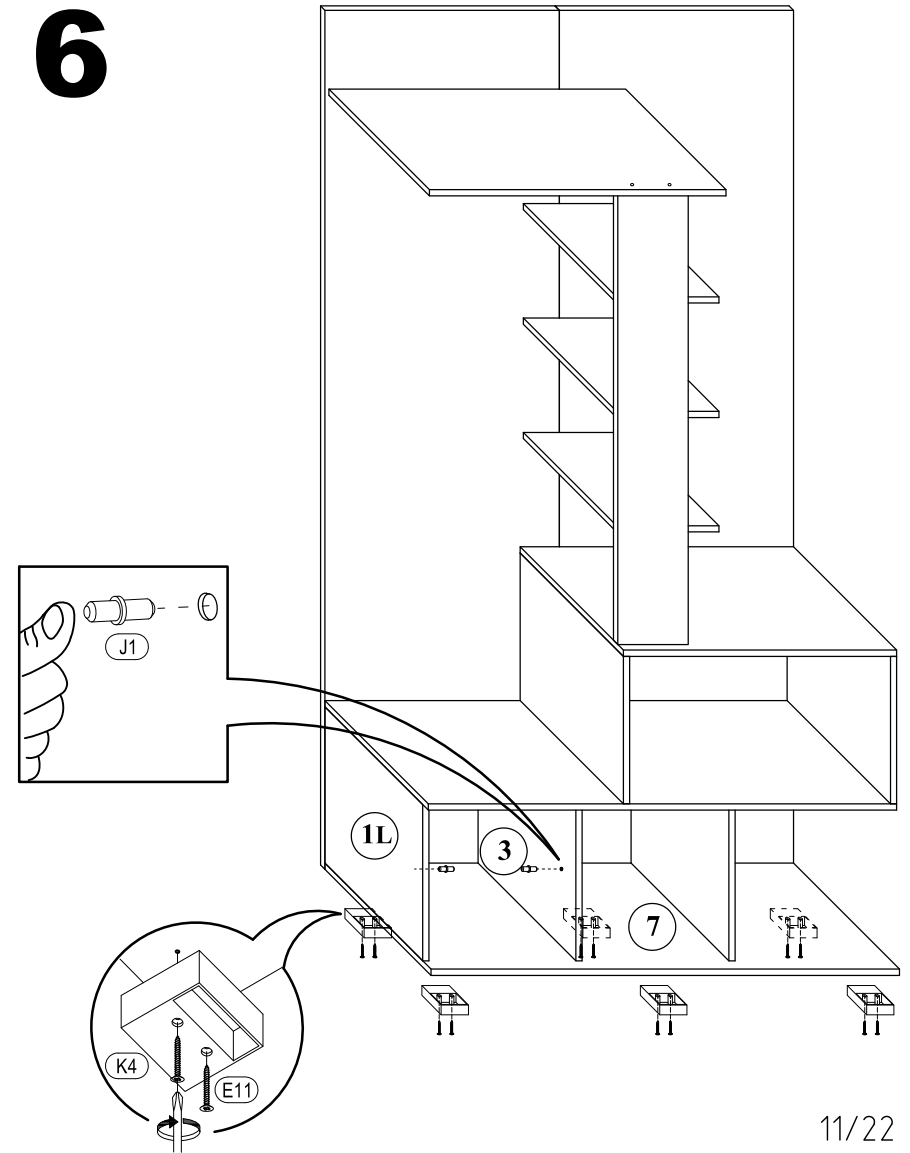

6

 <p>E11 4*35mm x12</p>	 <p>J1 5*16mm x16</p>	 <p>K4 x6</p>
--	---	---



E4  3*20mm x8	F5  6,3*13mm x4	L3  x2	N4  R+L x2
---	---	--	--

7

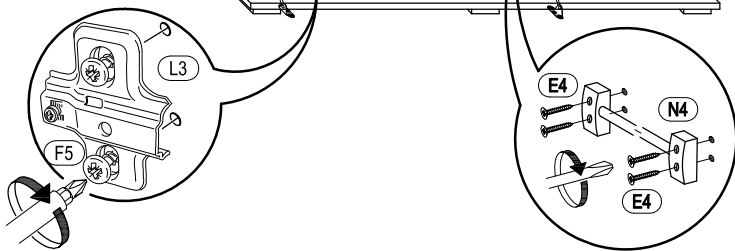
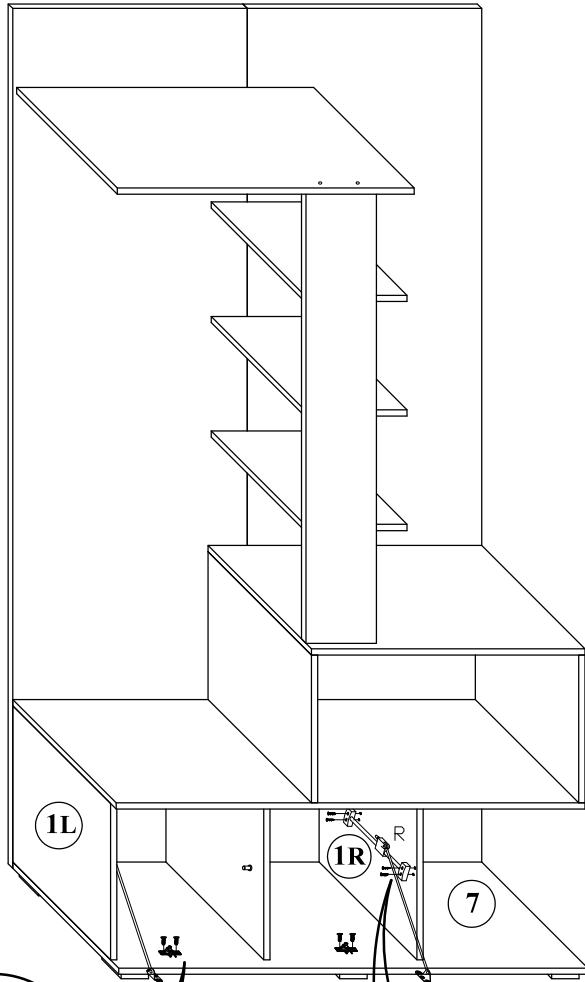

8

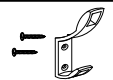
E8  4*16mm x4	X4  DW08 x3
---	---

