

# REPRIZE

---

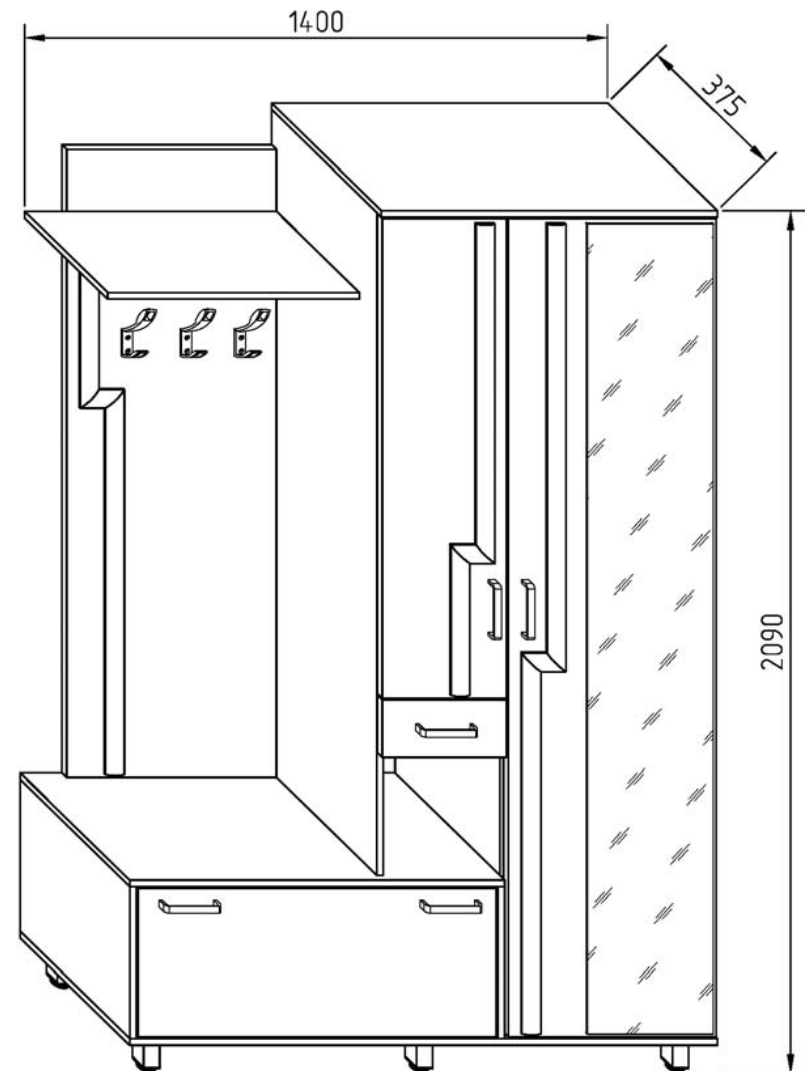

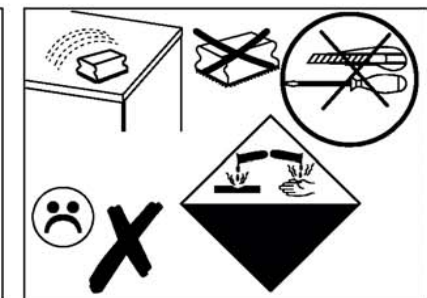

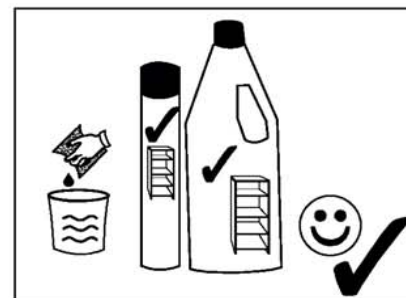
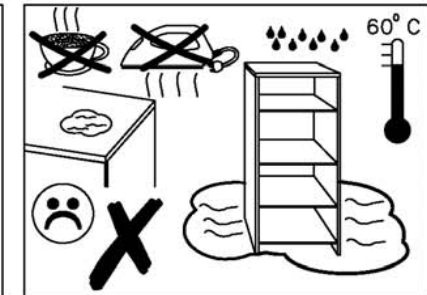
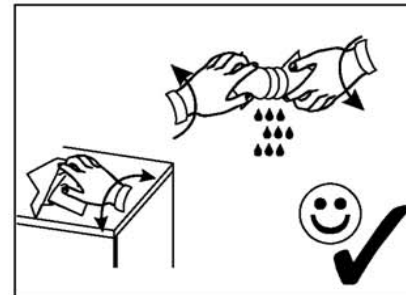
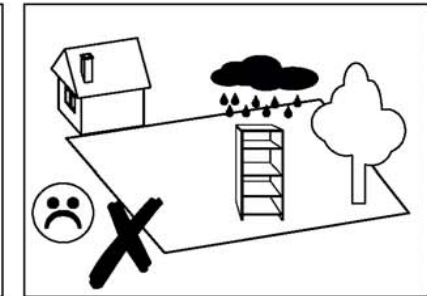
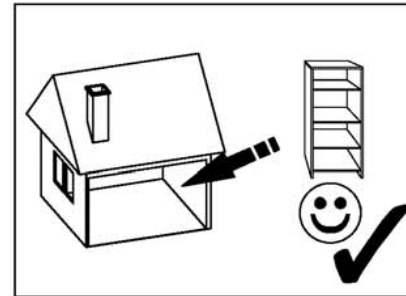
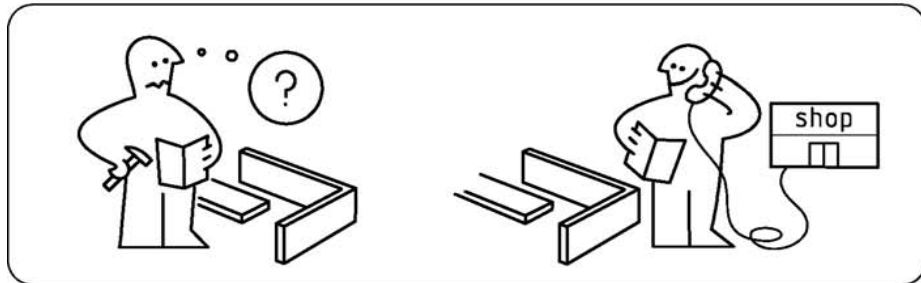
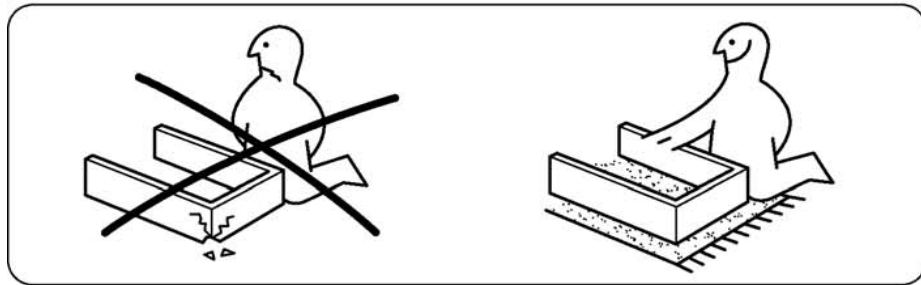
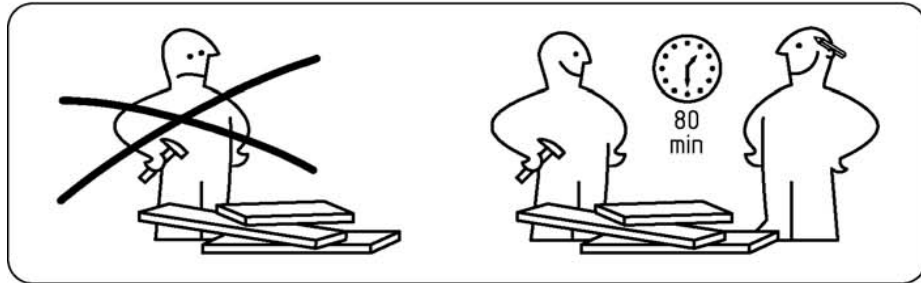
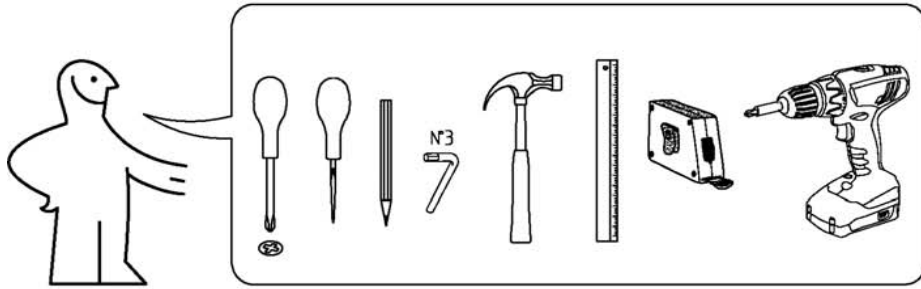



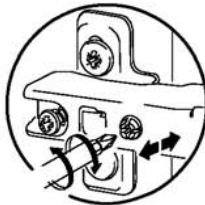
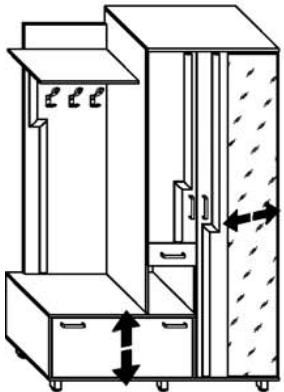
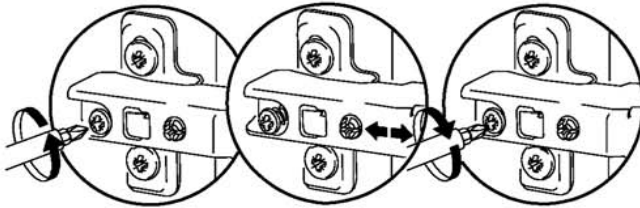
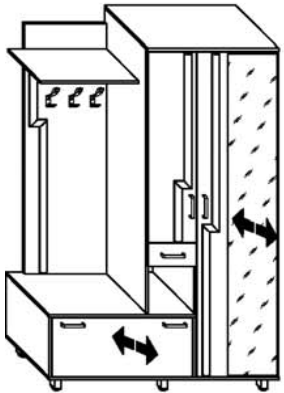
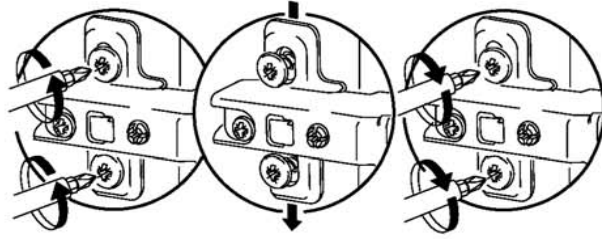
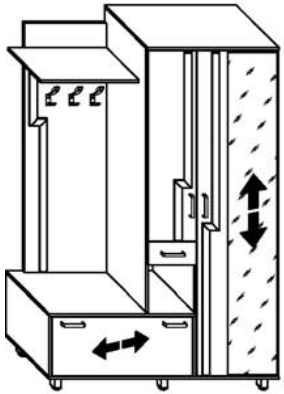





















# 15

REPRIZE



 A1 8*30mm x18	 B x20	 B1 6,3*50mm x35
 C1 5*30mm x2	 D x2	 D1 16mm x2
 E2 3*13mm x8	 E3 3*15mm x30	 E4 3*20mm x8
 E9 4*16mm x20	 E16 4,5*30mm x10	 F5 6,3*13mm x16
 G6 M 4*25mm x10	 H1 M 4 x10	 I21 128 x5
 J1 5*16mm x16	 K9 H-60mm x6	 L1 x6
 L3 x2	 M1 L-300mm x1	 N4 R+L x2
 N6 L-300 x1	 R1 x1	 R3 1,4*25mm 0.050kg
 R4 N4 x1	 X4 DW08 x3	

No	a*b	x	N°...
1R	2000x354	x1	3
1L	2000x354	x1	3
2	1614x354	x1	3
3R	370x370	x1	2
3L	370x370	x1	2
4	370x350	x1	3
5	1400x370	x1	2
6	800x370	x1	4
7	894x370	x1	2
8	474x354	x1	2
9	278x354	x1	2
10	278x345	x3	2
11	422x350	x1	2
12	600x280	x1	2
13	1528x500	x1	1
14	1990x496	x1	1
15	1168x296	x1	5
16	362x854	x1	4
17	140x296	x1	2
18R	300x100	x1	2
18L	300x100	x1	2
19	221x100	x1	2
20	303x250	x1	6
21	2028x495	x1	6
22	1631x300	x1	6
23	900x397	x1	6
		x1	2





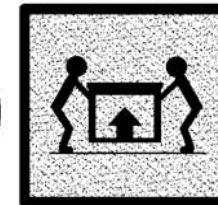
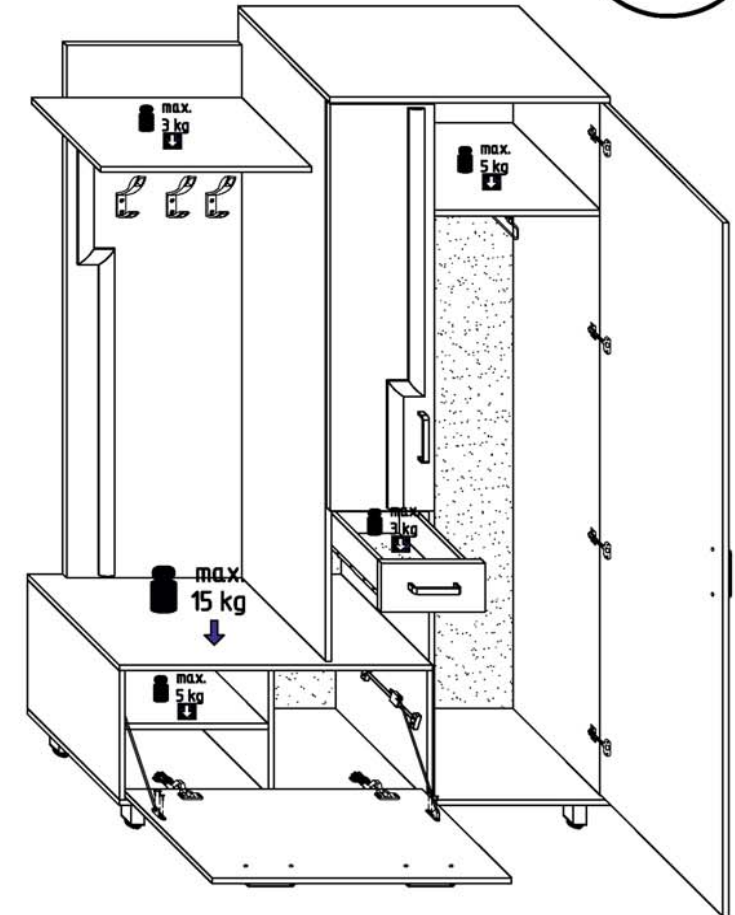
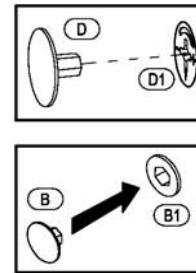

14



REPRIZE

13

 E3 3*15mm x6	 G6 M 4*25mm x8	 H1 M 4 x8
		 I21 128 x4

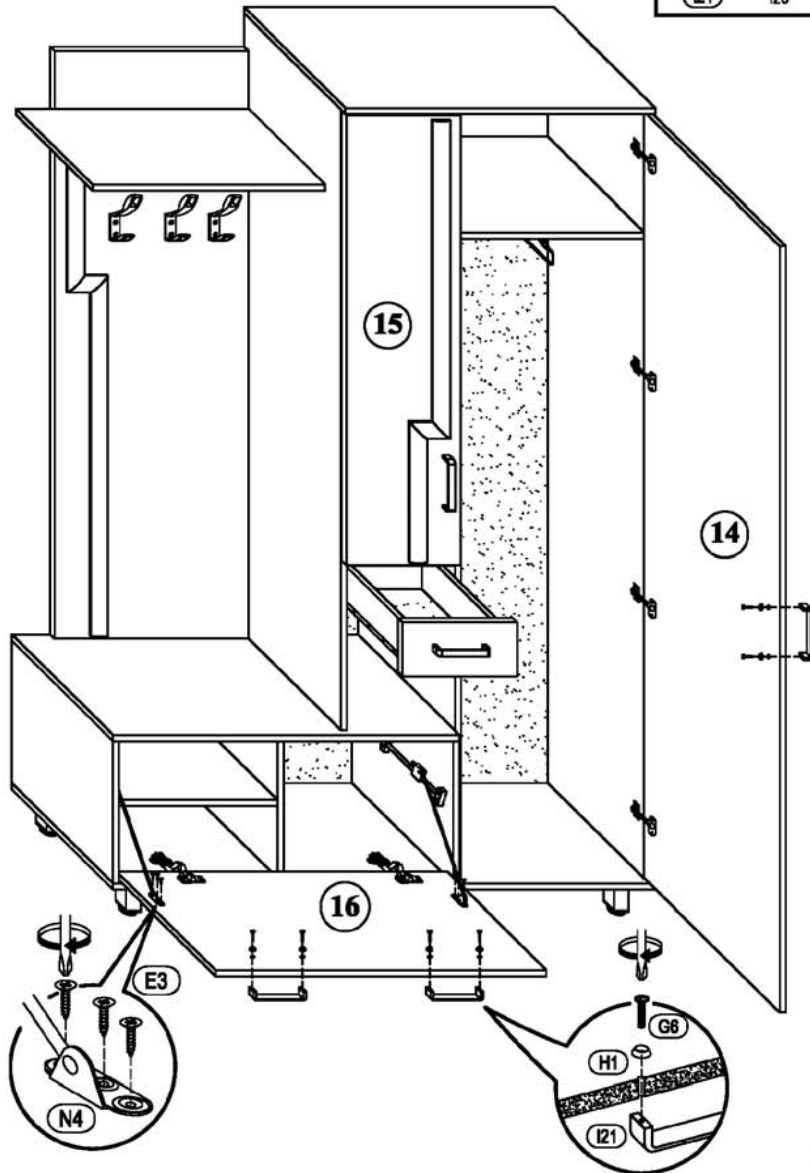

20/23

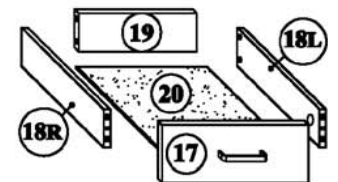
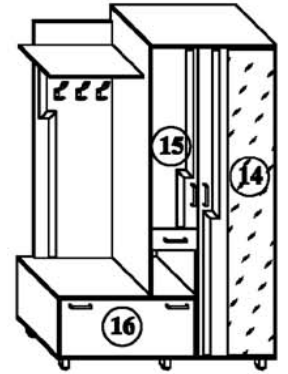
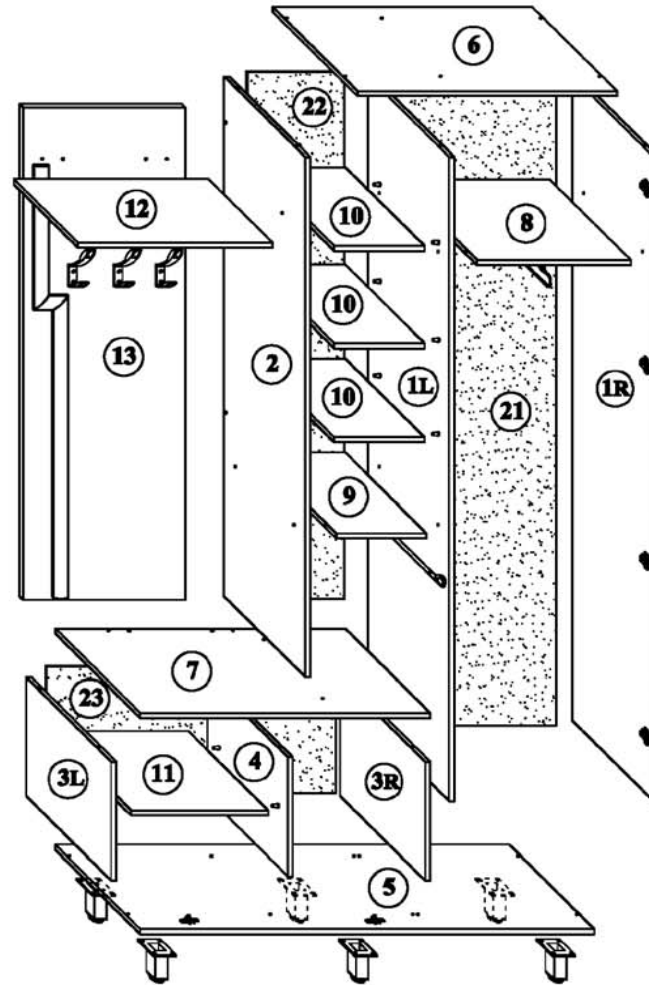

REPRIZE



5/23

REPRIZE

1

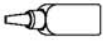
 A1 8*30mm x6	 B1 6,3*50mm x6	 R4 N4
		 R1

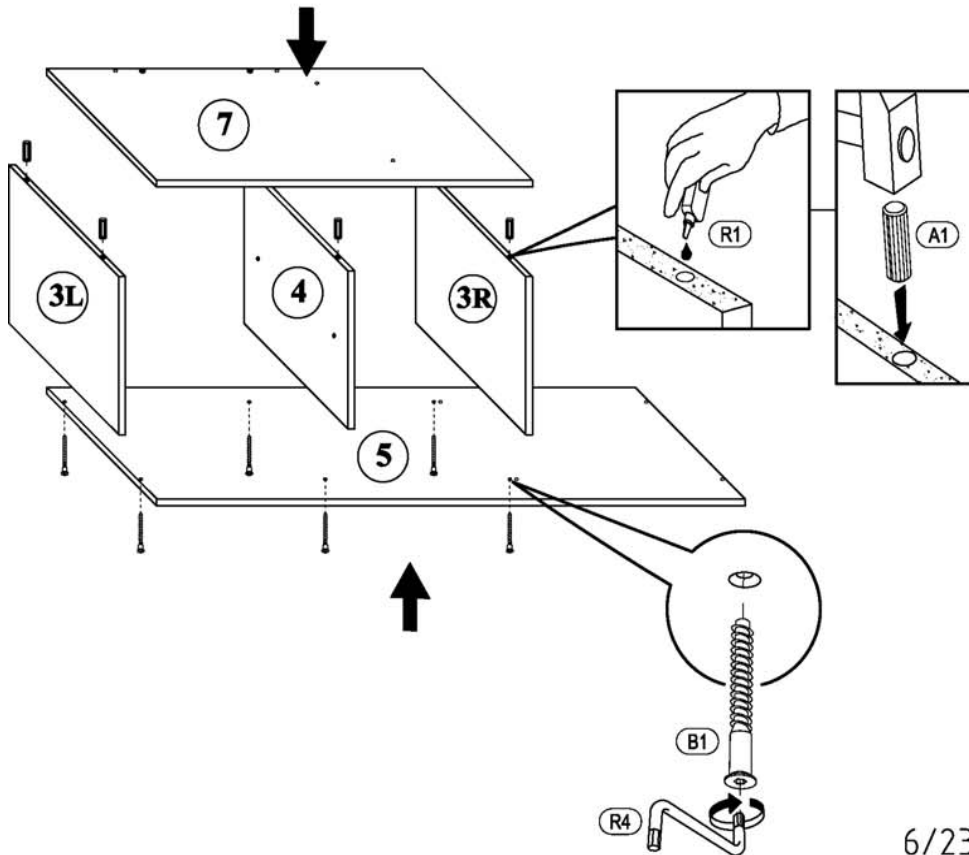
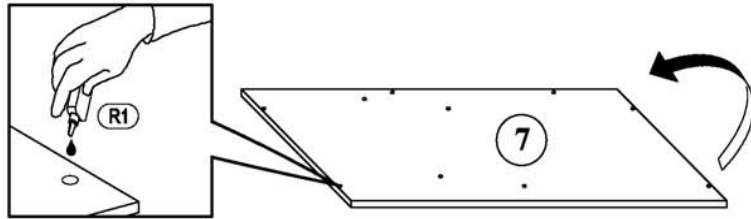

6/23

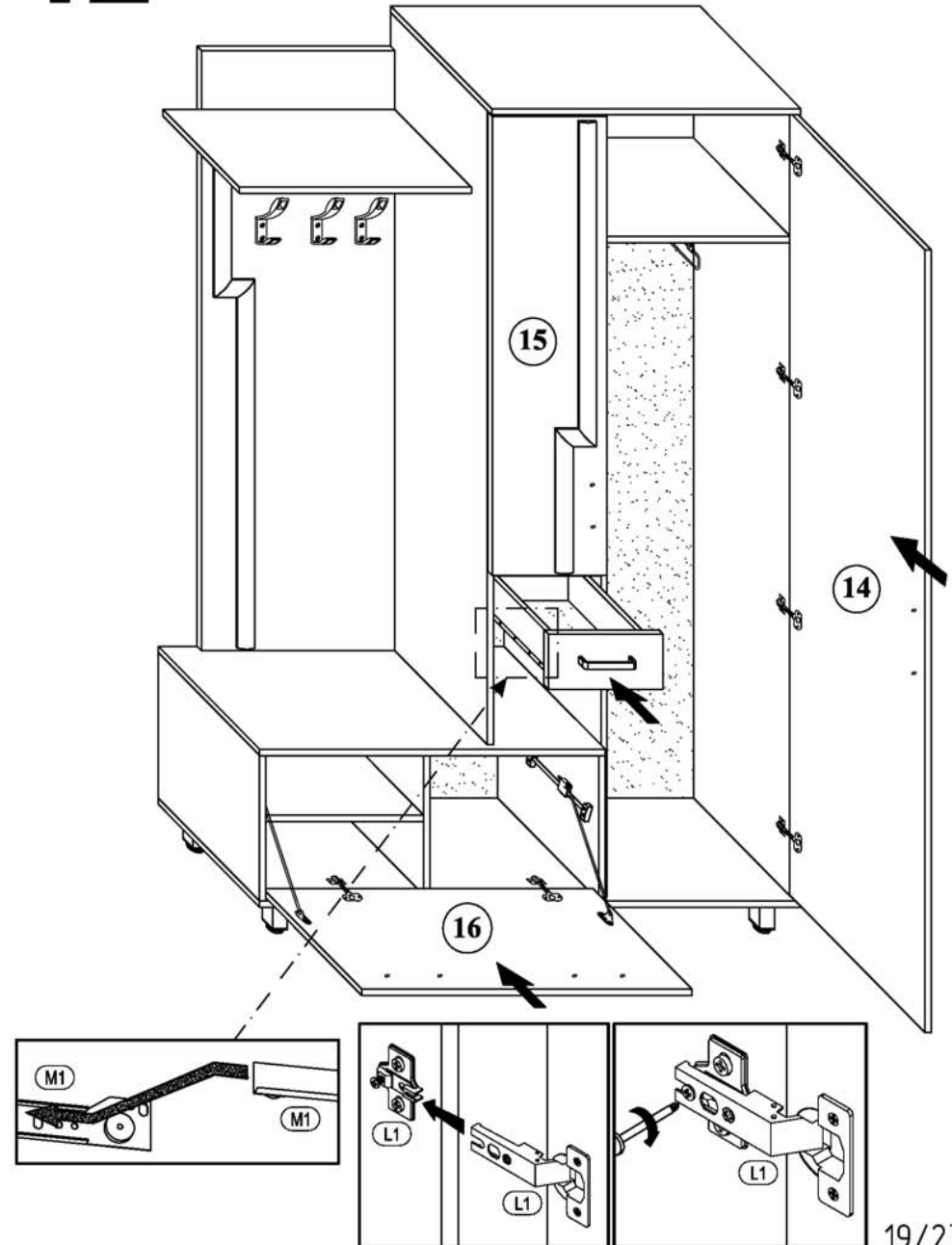

12

REPRIZE



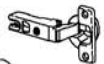

19/23

11

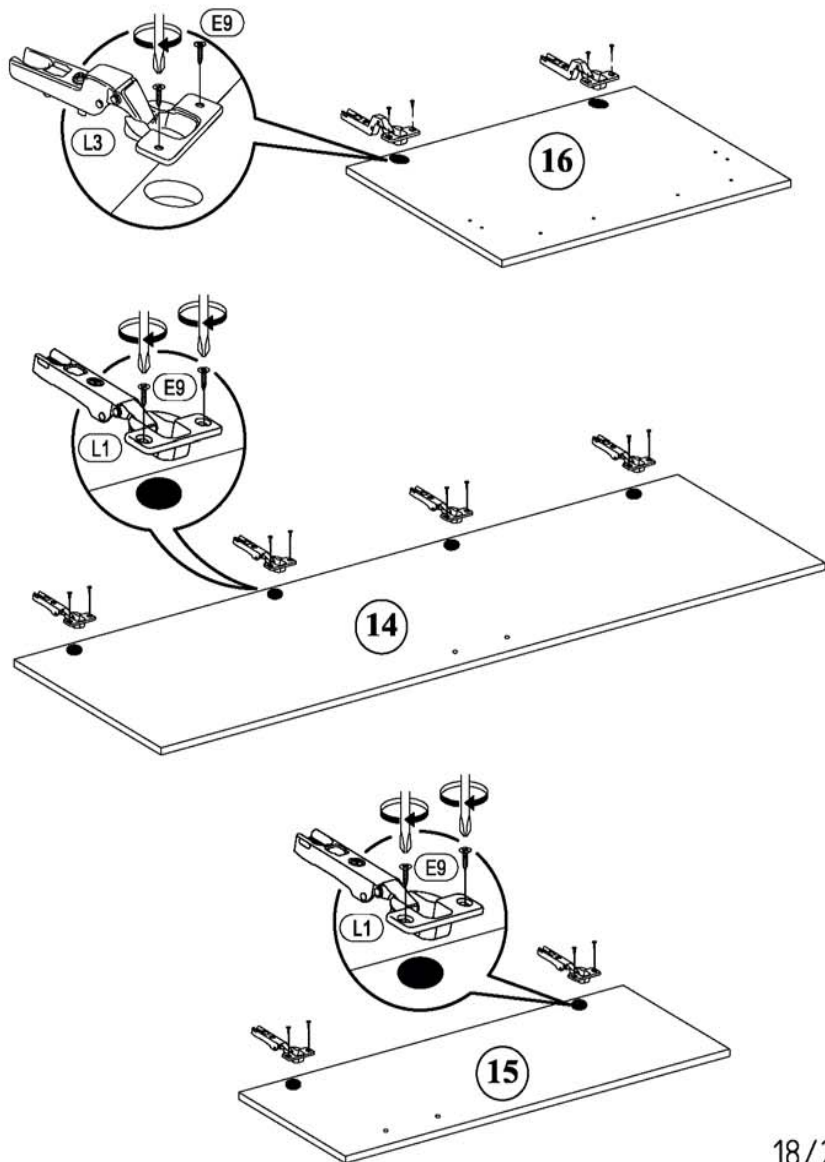
 E9	4*16mm	x12	 L1	x2	 L3	x6
--------------------------------------------------------------------------------------	--------	-----	--------------------------------------------------------------------------------------	----	--------------------------------------------------------------------------------------	----



2

 B1	6,3*50mm	x8	 R4	N°4
----------------------------------------------------------------------------------------	----------	----	----------------------------------------------------------------------------------------	-----

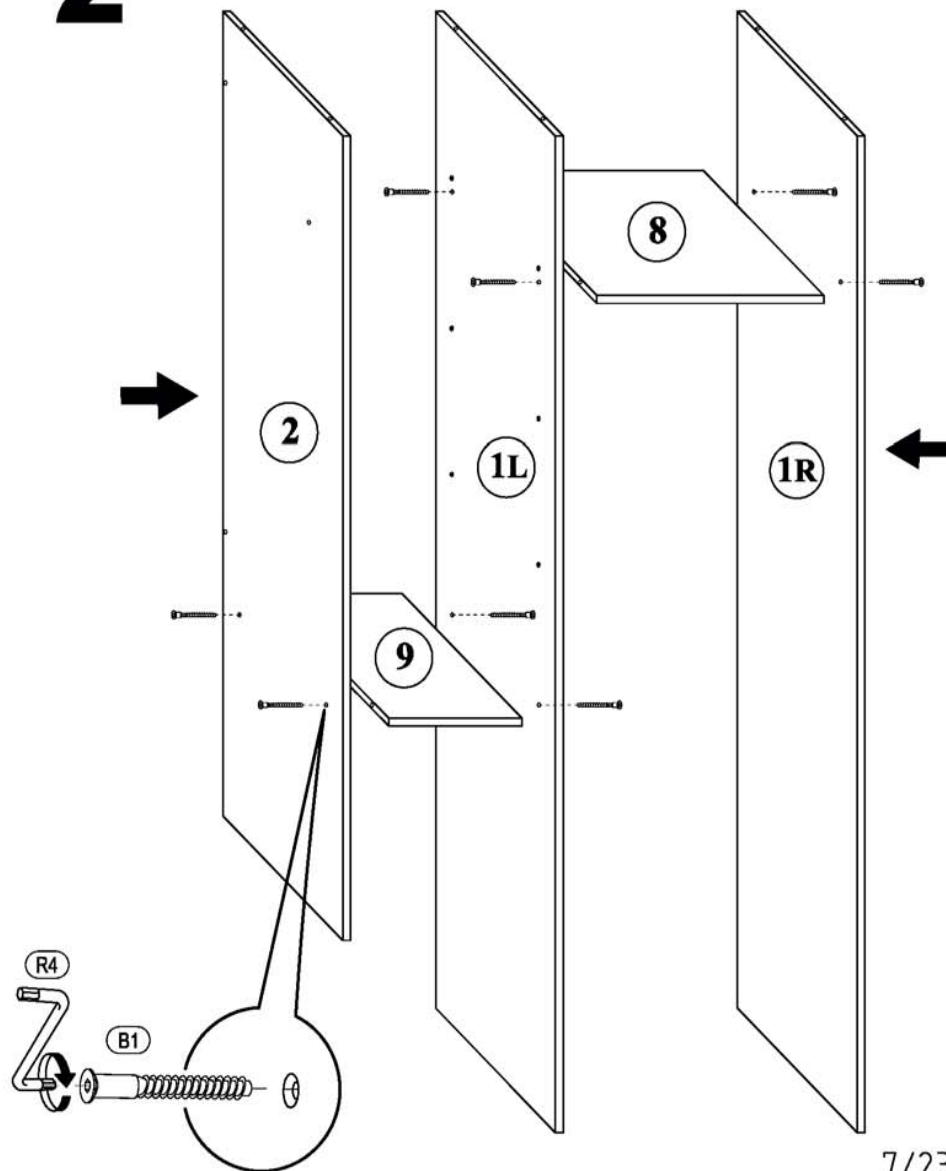

<b>(B1)</b> 6,3*50mm x6	<b>(E2)</b> 3*13mm x4	<b>(M1)</b> R+L x1
		<b>(R4)</b> N°4

**3**

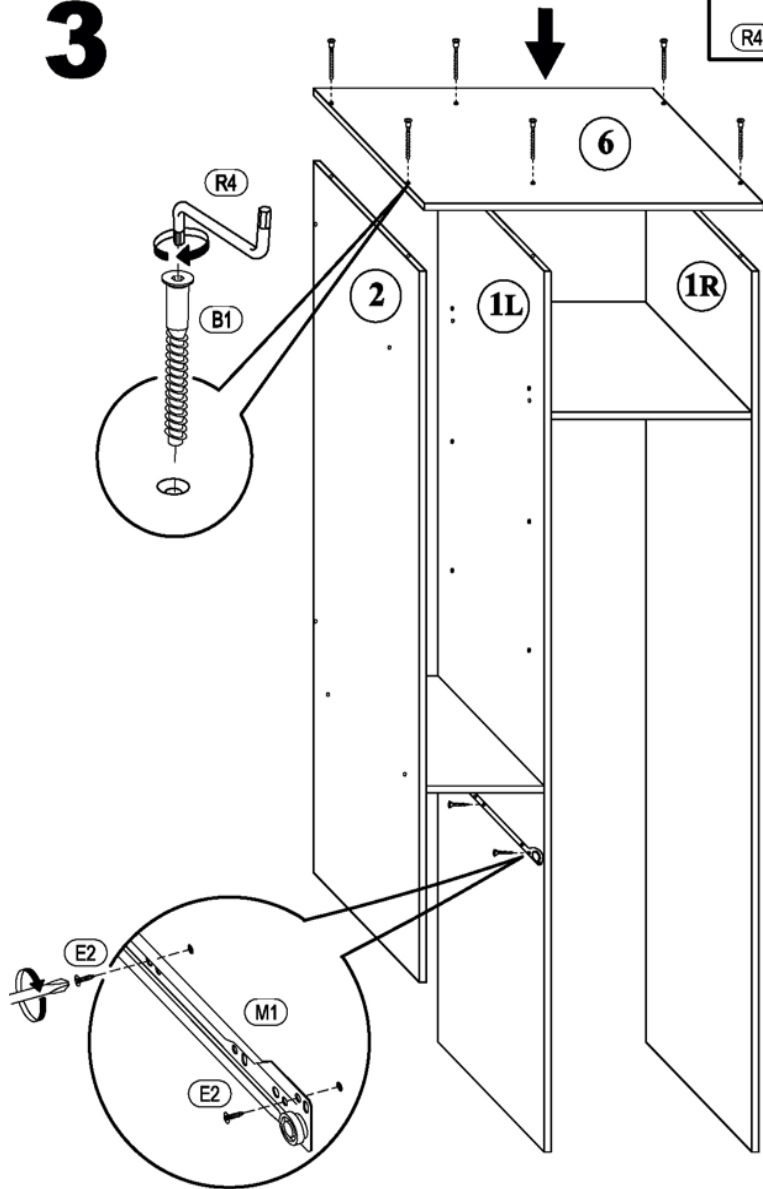

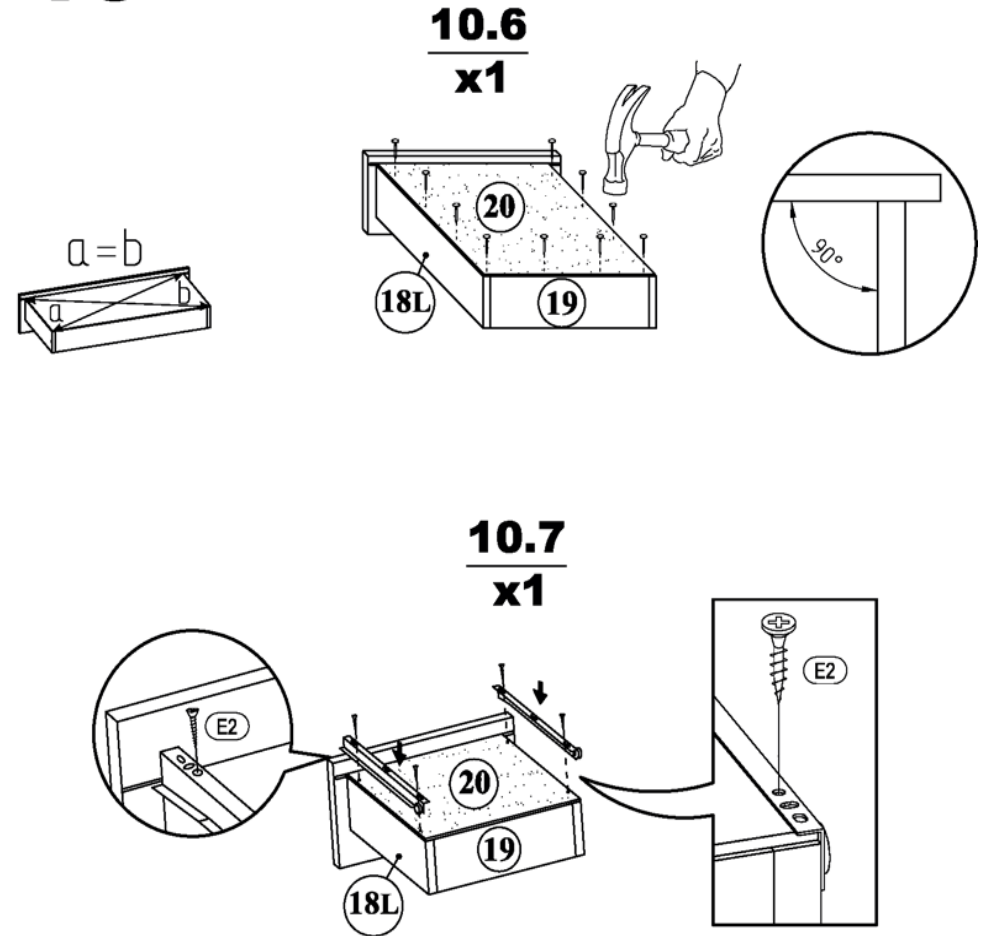

<b>(M1)</b> R x1	<b>(E2)</b> 3*13mm x4	<b>(R3)</b> 1,4*25mm 0,010kg
------------------------	-----------------------------	------------------------------------

**10**





 <p>A1 8*30mm x4</p>	 <p>D1 16mm x2</p>
-------------------------------------------------------------------------------------------------------	-----------------------------------------------------------------------------------------------------

# 10

## 10.4 x1

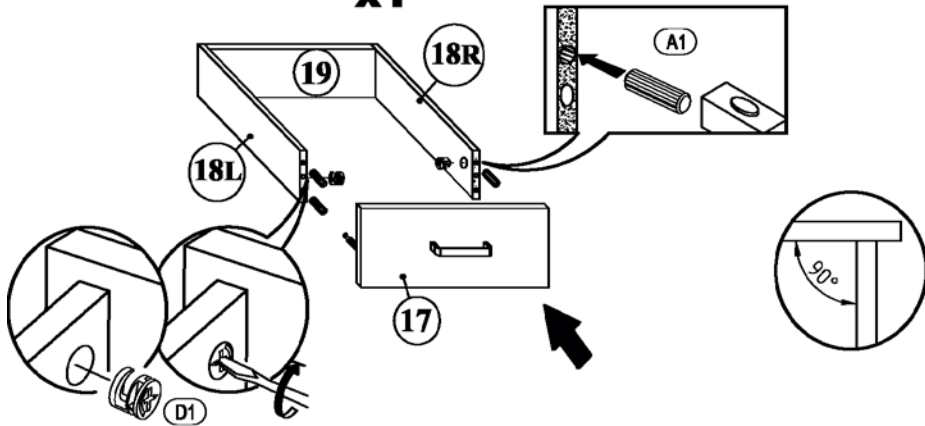

## 10.5 x1

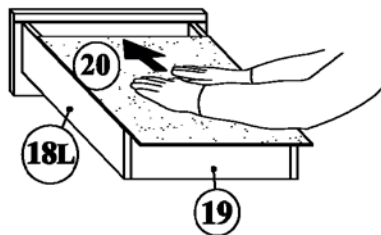

# 4



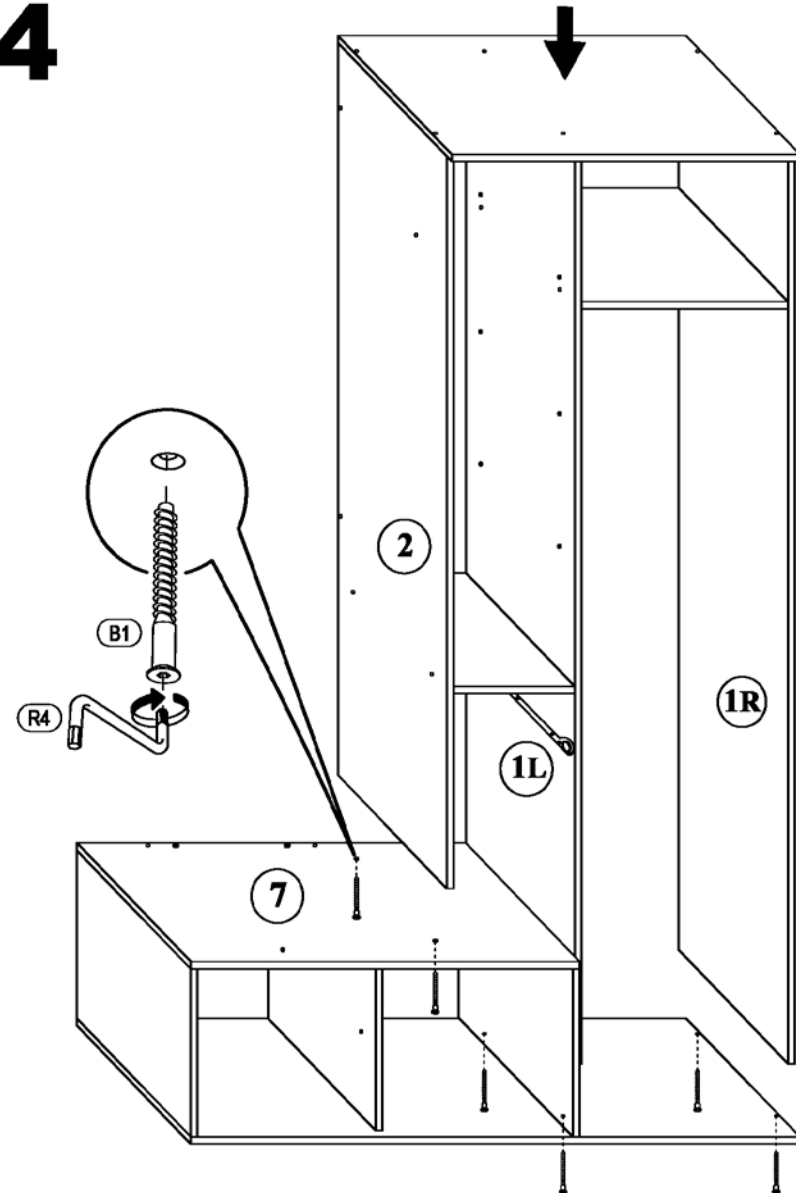

 <p>B1 6,3*50mm x6</p>	 <p>R4 N°4</p>
-----------------------------------------------------------------------------------------------------------	---------------------------------------------------------------------------------------------------

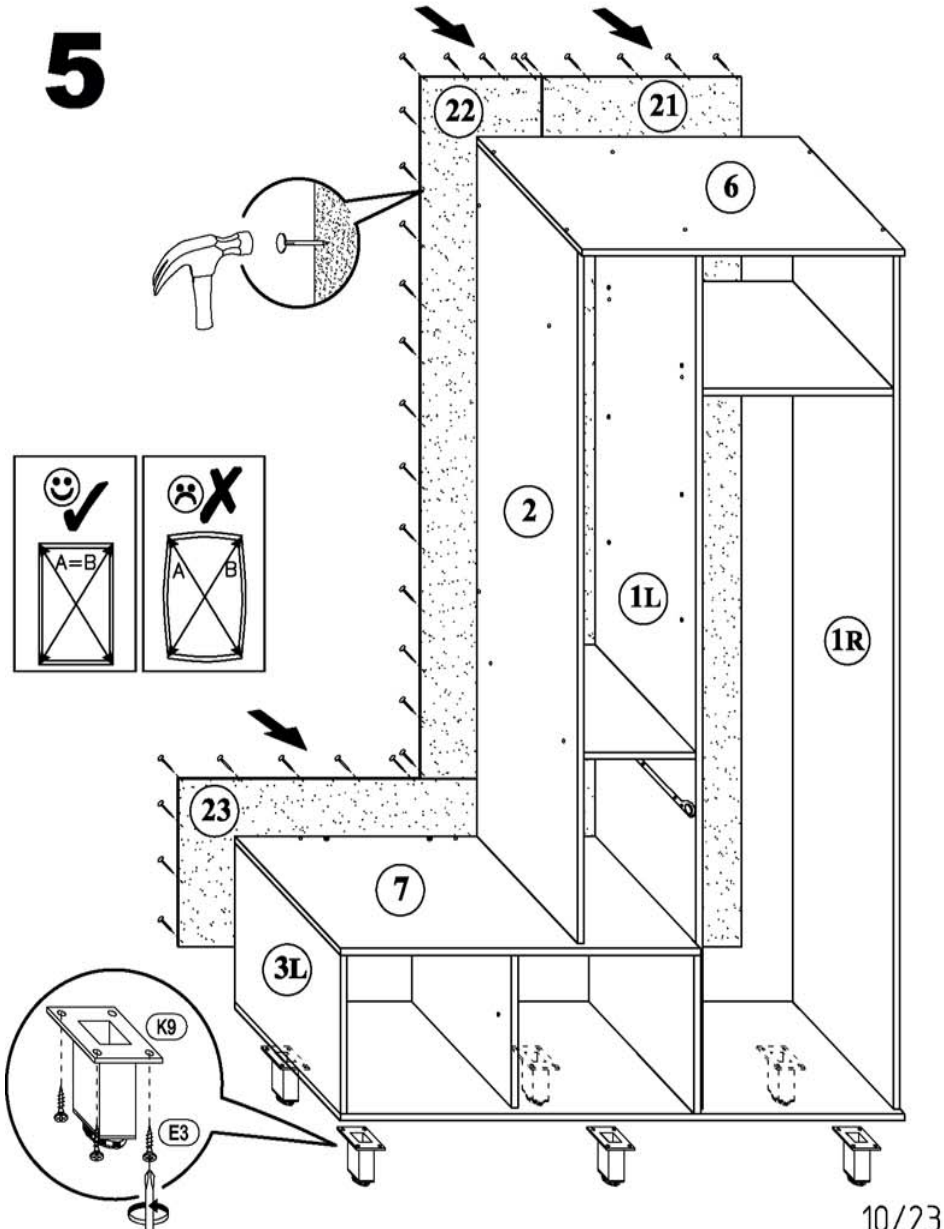

 E3 3*15mm x24	 K9 x6	 R3 1.4*25mm 0.040kg
-------------------------------------------------------------------------------------------------	-----------------------------------------------------------------------------------------	-------------------------------------------------------------------------------------------------------



5



 A1 8*30mm x4	 C1 5*30mm x2	 G6 M 4*25mm x2
 H1 M 4 x2	 I21 128 x1	

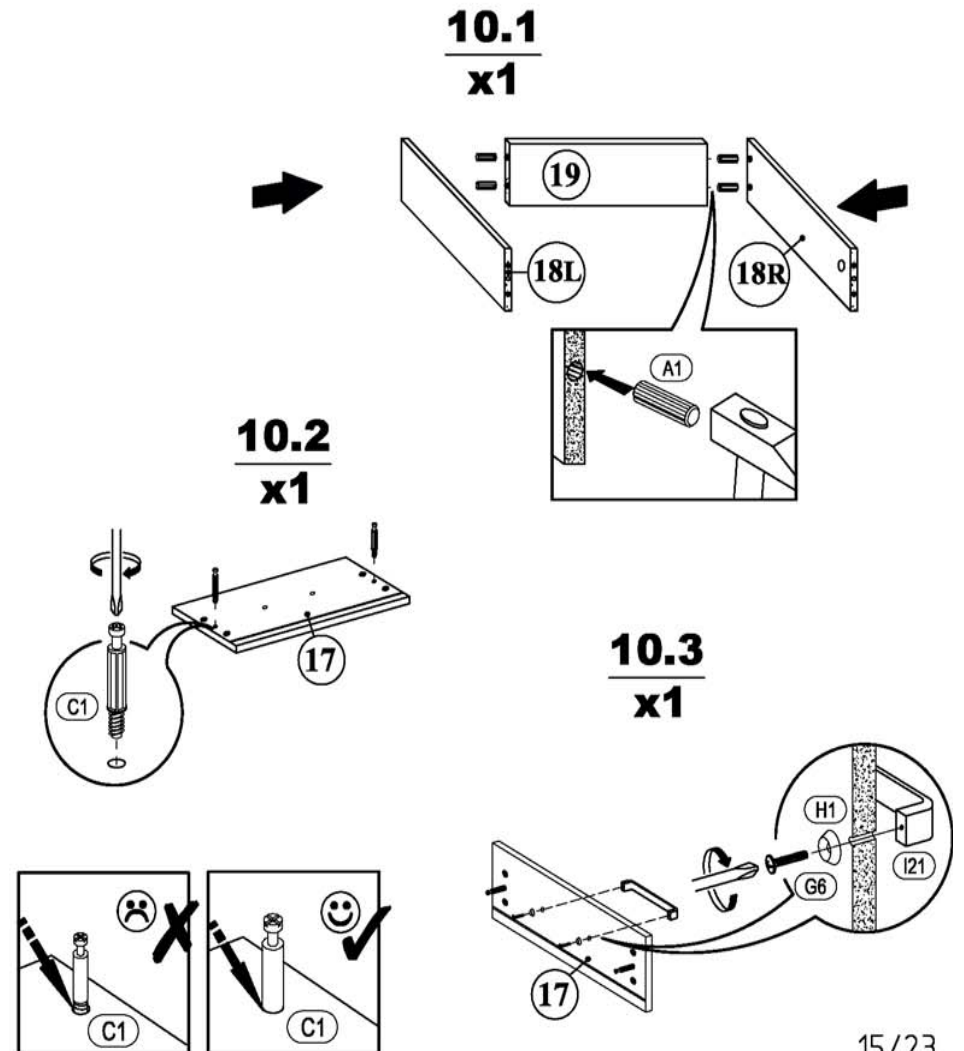

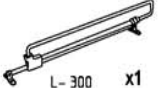
10



 E9 4*16mm x4	 N6 L-300 x1	 X4 DW08 x3
---------------------------------------------------------------------------------------------------	--------------------------------------------------------------------------------------------------	-------------------------------------------------------------------------------------------------

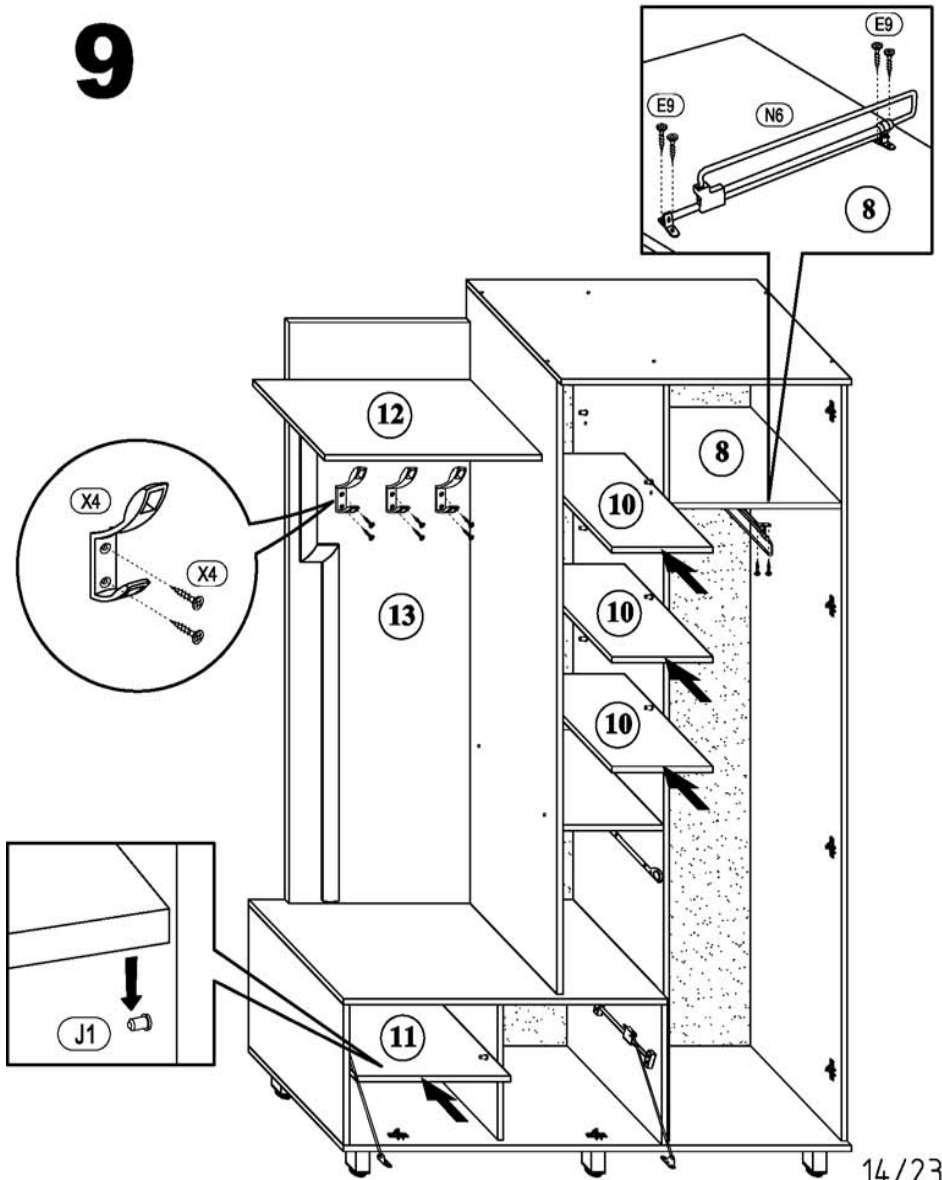

9



 A1 8*30mm x2	 B1 6,3*50mm x2	 R4 N4
-----------------------------------------------------------------------------------------------------	-------------------------------------------------------------------------------------------------------	----------------------------------------------------------------------------------------------

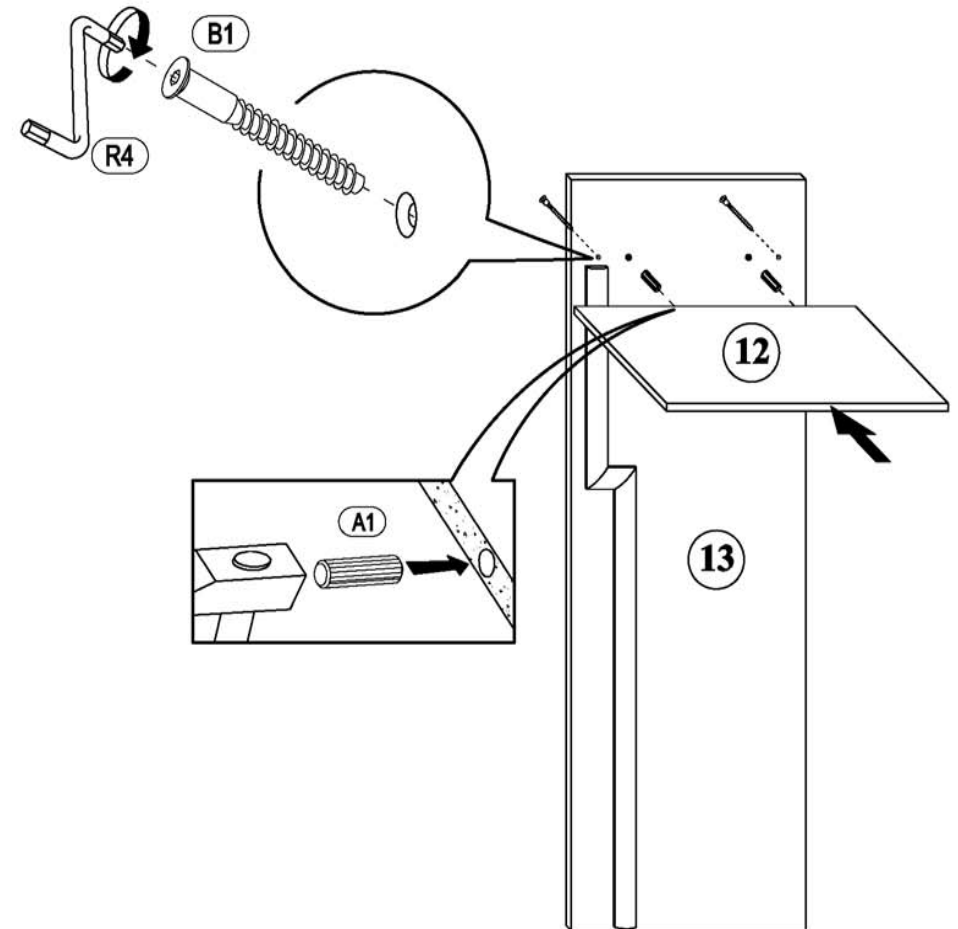



6

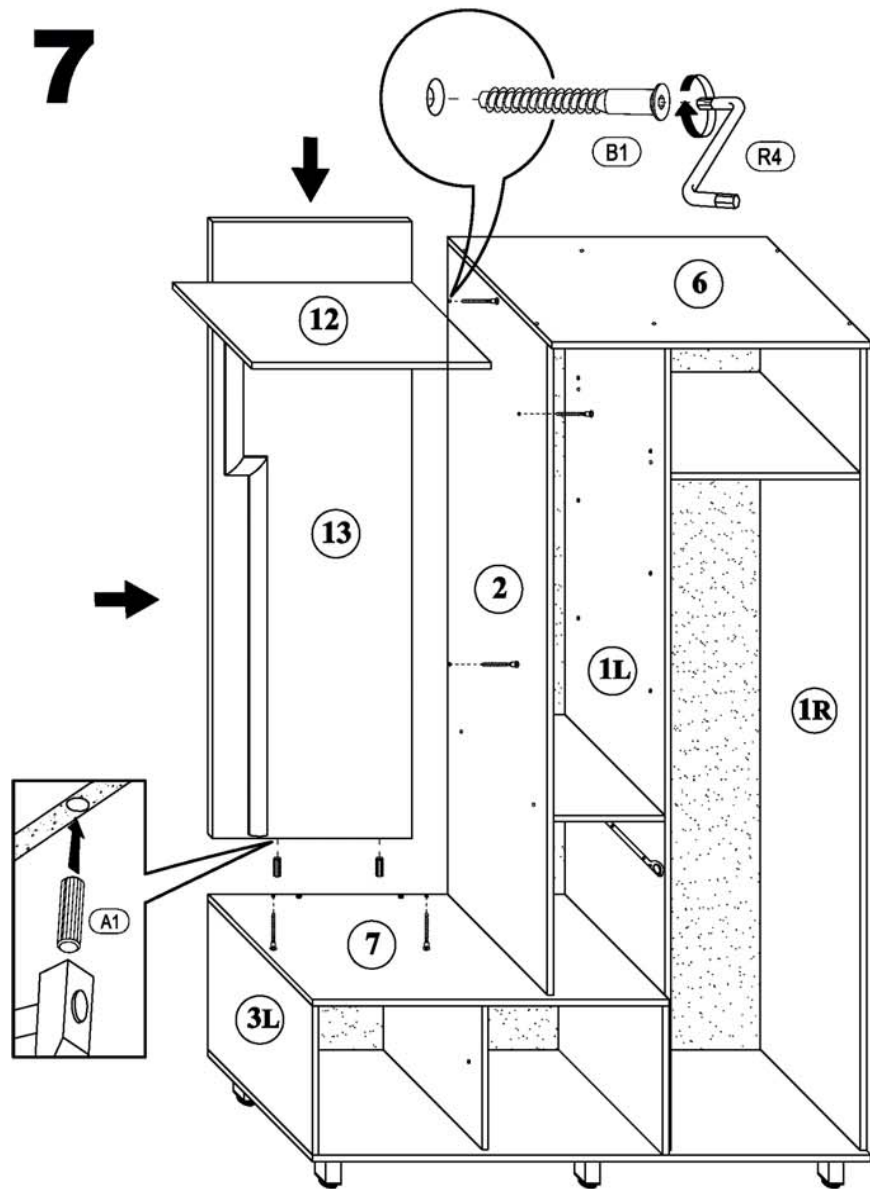

		
(A1) 8*30mm x2	(B1) 6,3*50mm x5	(R4) N4

7

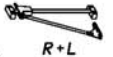

			
(E4) 3*20mm x8	(F5) 6,3*13mm x16	(J1) 5*16mm x16	(L1) x6
			
		(L3) x2	(N4) R+L x2

8

