

Секция Версал

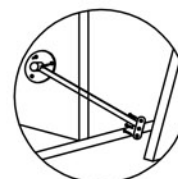

ВИНТ 3,5/16 мм

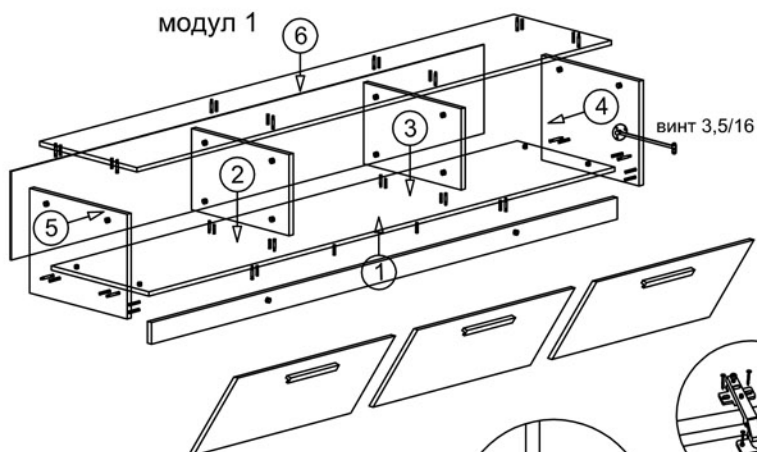
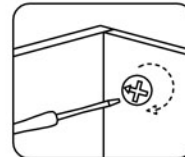
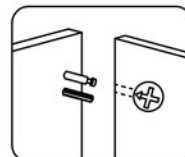
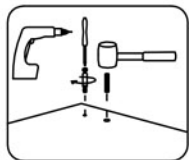
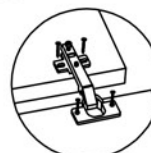

ВИНТ 3,5/16 мм

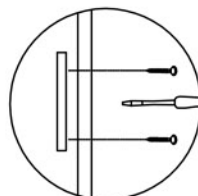

ВИНТ 4/30мм

модул 2

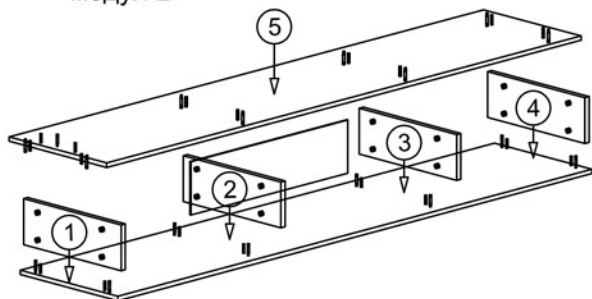

модул 3

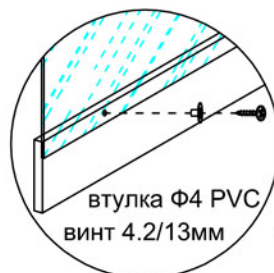
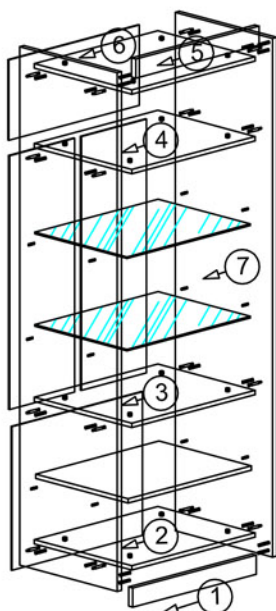

втулка Ф4 PVC
ВИНТ 4.2/13мм

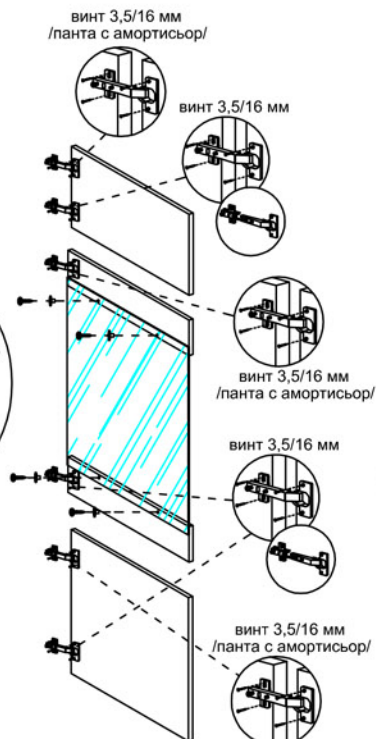

винт 3,5/16 мм
/панта с амортисьор/

винт 3,5/16 мм

винт 3,5/16 мм
/панта с амортисьор/

винт 3,5/16 мм

винт 3,5/16 мм
/панта с амортисьор/

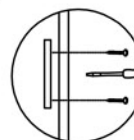

ВИНТ 4/30мм

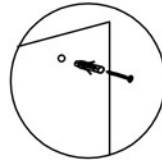
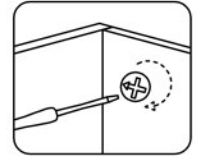
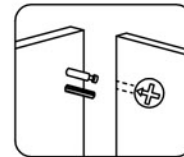
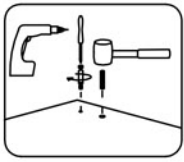

дюбел + винт 6/80 мм

модул 4

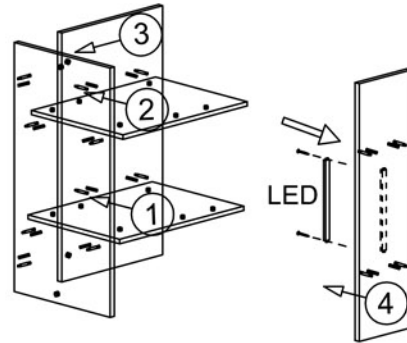

модул 5



ВИНТ 3,5/16мм

дюбел и винт 6/80мм

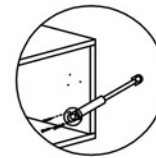
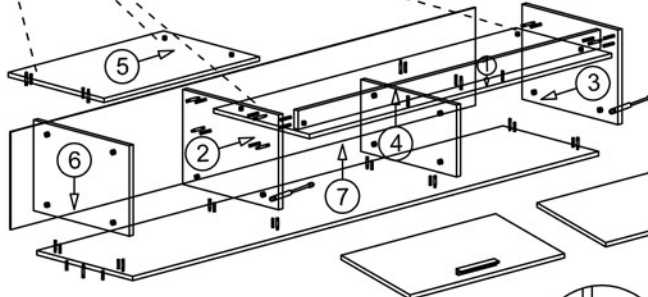

ВИНТ 3,5/16 мм

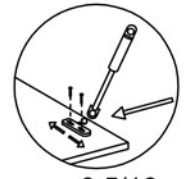

ВИНТ 3,5/16 мм

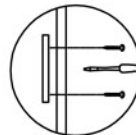

ВИНТ 4/30мм

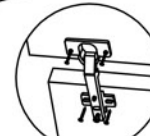

ВИНТ 3,5/16 мм

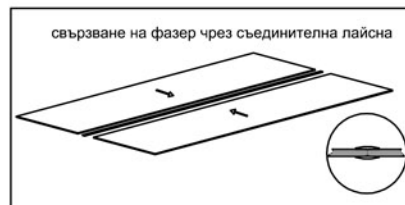

свързване на фазер чрез съединителна лансна



схема за сглобяване на чекмедже

ВИНТ 3,5/30 мм

ВИНТ 4x45мм

ВИНТ 3,5/20мм

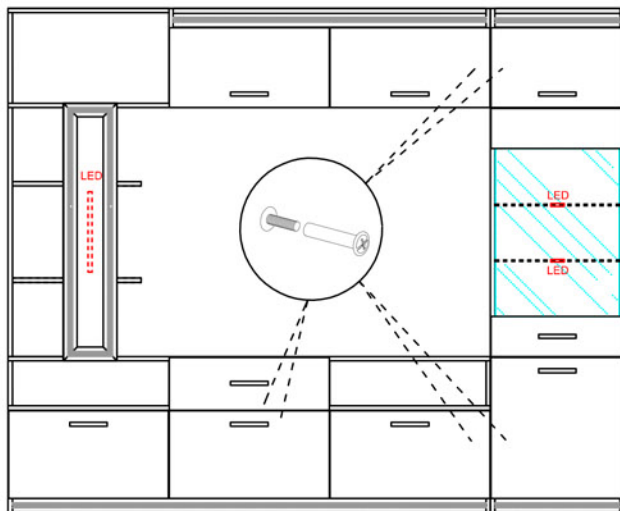
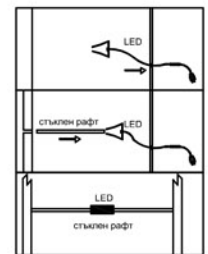